



Products: FSIQ, SMIQ

Tests on 3G-Base Stations to TS 25.141 with FSIQ and SMIQ

Application Note

This application note describes how to measure the various WCDMA signals which are used for transmitter tests on FDD base stations with an FSIQ signal analyzer, and how to generate the diverse stimulus signals needed for receiver and performance tests with an SMIQ signal generator.

The demo program 3GdemoBS is included. Run 3GDemoBS to set up the instruments and carry out the tests to TS 25.141 via remote control. The demo program is distributed as source code; adopt the remote control commands and test sequences for your own test routines, and integrate FSIQ and SMIQ into your test systems with maximum ease.



Contents

1	Overview	4
2	Installing of the demo program 3GDemoBS	5
3	Principles of Operation	6
	First steps with the demo program	6
	Advanced information about the demo program	8
	Uncertainty of the complete test system	9
4		9
5		9
6	Transmitter Tests	10
	Test set up for transmitter tests	11
	Transmitter tests step by step	12
	Base station maximum output power (6.2.1)	13
	CPICH power accuracy (6.2.2)	14
	Frequency error (6.3)	17
	Power control steps (6.4.2)	19
	Power control dynamic range (6.4.3)	21
	Total power dynamic range (6.4.4)	23
	Occupied bandwidth (6.5.1)	25
	Spectrum emission mask (6.5.2.1)	27
	Adjacent Channel Leakage Power Ratio (6.5.2.2)	29
	Spurious emissions (6.5.3)	31
	Spurious emissions Category A (6.5.3.4.1)	32
	Spurious emissions Category B (6.5.3.4.2)	33
	Protection of the base station receiver (6.5.3.4.3)	33
	Co-existence with GSM 900 (6.5.3.4.4)	34
	Co-existence with DCS 1800 (6.5.3.4.5)	34
	Co-existence with PHS (6.5.3.4.6)	35
	Co-existence with services in adjacent bands (6.5.3.4.7)	35
	Co-existence with UTRA-TDD (6.5.3.4.8)	36
	Transmit intermodulation (6.6)	36
	Error Vector Magnitude (6.7.1)	37
	Peak Code Domain Error (6.7.2)	39
7	Receiver Tests	41
	Test Setup for Receiver tests	41
	Receiver Test Demonstration Step by Step	42
	Reference Sensitivity Level (7.2)	43
	Dynamic Range (7.3)	45
	Adjacent Channel Selectivity (7.4)	46
	Blocking Characteristics (7.5)	48
	Intermodulation Characteristics (7.6)	49
	Spurious Emissions (7.7)	51
	Verification of Internal BER Calculation (7.8)	53
8	Performance Tests	53
	Test Setup for Performance Tests	54
	Performance Test Demonstration Step by Step	55
	Demodulation of DCH in Static Propagation Conditions (8.2)	55
	Demodulation of DCH in Multipath Fading Conditions (8.3)	57
	Demodulation of DCH in Moving Propagation Conditions (8.4)	60
	Demodulation of DCH in Birth / Death Conditions (8.5)	61
	Verification of Internal BLER Calculation (8.6)	62
9	Test Signals Only	63
	Synchronising Base Station and SMIQ	64
	Generating Test Signals	64
10	Literature	65
11	Abbreviations	66
12	Hardware and Software Requirements	67

Tests on 3G - Base Stations

3GDemoBS Hardware Requirements for PC.....	67
3GDemoBS Software Requirements for PC	67
Options required for FSIQ and SMIQ	67
13 Ordering information.....	70
14 Contact	70

1 Overview

This application note describes how to measure the various WCDMA signals which are used for transmitter tests on FDD base stations with an FSIQ signal analyzer, and how to generate the diverse stimulus signals needed for receiver and performance tests with an SMIQ signal generator.

The demo program 3GDemoBS is included. Run 3GDemoBS to set up the instruments and carry out the tests to TS 25.141 via remote control.

Figure 1 shows the basic test set up for this application note:

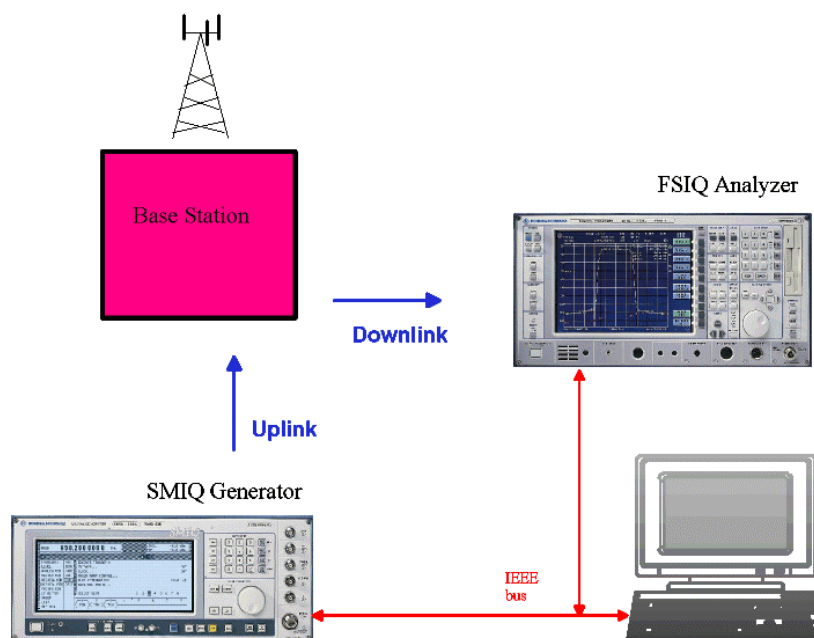

Fig. 1: Basic test set up

The combination of SMIQ and FSIQ can run every test that the specification TS 25.141 stipulates. Some tests, however, need two SMIQ generators, or additional signal sources for interference. For these cases, the program 3GDemoBS demonstrates the principle of the tests, and generates the single signals subsequently.

The program 3GDemoBS can also set up the SMIQ to provide any type of test model and uplink reference measurement channel without running a test.

Demo Mode:

If there is no base station available, simulate the downlink signal with SMIQ. For receiver and performance tests, monitor the uplink test signal with FSIQ. Both tasks are supported by 3GDemoBS automatically.

The demo program is distributed as source code; adopt the remote control commands and test sequences for your own test routines, and integrate FSIQ and SMIQ into your test systems with maximum ease.

To modify the code and generate a version of your own, you need the LabWindows CVI software from National Instruments Rev. 5.5 or higher.

The following pages describe how to use the 3GDemoBS demo program and give a detailed description of each transmitter, receiver and performance test.

Notes: For 3GPP base stations, Rohde & Schwarz offers the TS9850 Test System, for measurements at the air interface CMU200 / 300 Universal Radio Communication Tester, see section *Ordering Information*.

An overview of the application notes currently available for 3GPP from Rohde & Schwarz is given in section 10 on page 65.

For a list of abbreviations used in this application note, see section 11 on page 66.

2 Installing of the demo program 3GDemoBS

The 3GPP tests require some specific hardware and software options in both the SMIQ generator and FSIQ analyzer.

1. Check the hardware and software requirements. See the section 12 on page 67.
2. Install the 3GDemoBS demo program on your computer. You need the four files:
 - 3GDemoBS.MSI
 - DistFile.cap
 - Setup.ini
 - Setup.exe

Download the sites from

<http://www.rohde-schwarz.com> --> products --> Application Notes

Search for 1MA38.

If the Microsoft Installer is not yet available at your PC, download it from the R&S website containing 1MA38, and install it first.

3. Run Setup.exe.
4. Follow the instructions of the installation dialog.

Note: If the installation program finds an older version of 3GdemoBS on your computer, it will deinstall this version first. After the deinstallation, run Setup.exe again to install the new version.

3 Principles of Operation

First steps with the demo program

For running transmitter tests, you need the FSIQ analyzer. For receiver and performance tests with the demo program, you need at least one SMIQ generator.

Note: To navigate through the 3GDemoBS program without any instruments connected, continue from step 3.

1. Connect the FSIQ analyzer and SMIQ generator to the controller via the IEEE bus.
2. Switch the analyzer and the generator on. Wait until initialisation is completed.
3. Run 3GDemoBS.exe.

On program start, the demo program checks whether the FSIQ and SMIQ are connected to the IEC/IEEE-bus, and stores the corresponding addresses. If only one or no instrument is detected, a message is output to indicate that the missing instruments will be simulated.

After a program start with both analyzer and generator connected, the user panel comes up:

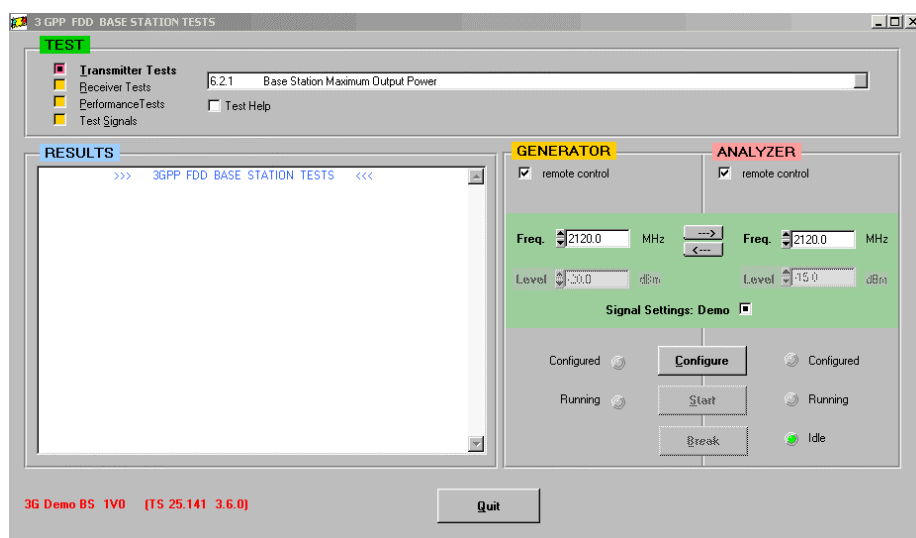

Fig. 2: 3GDemoBS user panel

In the *TEST* field above, the type of test (e.g. Transmitter Test), and the test itself (e.g. 6.2.1 Base Station Maximum Output Power) are selected.

Tests on 3G - Base Stations

Clicking *Test Help* will give you an overview of the test purpose and the method of test.

Set instrument parameters in the two fields *GENERATOR* and *ANALYZER*. Enter the frequency and level for the generator and analyzer. Three buttons control the program flow, LEDs indicate the instrument status.

Tests results are displayed in the *RESULTS* window on the left.

To run a test:

1. Prepare and connect the Device Under Test (DUT).
2. Select the test from the test list in the *TEST* field.
3. Adjust frequency and level, if necessary, in the parameter field.
4. Configure the instruments by clicking the *Configure* button.
5. Start the test by clicking the *Start* button.
6. Check the results in the *RESULTS* window.

Clicking the *Configure* button sets up both FSIQ and SMIQ completely. If you don't need both instruments, you can disable the program control for the unused device. This speeds up the configuration process considerably.

This also applies if you want to make two tests subsequently which need the same generator configuration, for example, configure the generator for the first test, and disable the program control for the generator before you click the *Configure* button for the second test. This will be described more in detail later.

Once the instruments are configured, you can repeat a test by clicking *Start* again (without a new configuration).

Special features:

Signal Settings Demo:

To run 3GDemoBS program without a base station, SMIQ and FSIQ have to be set up with the output from the generator connected to the input of the analyzer. Activating the checkbox *Signal Settings Demo* presets the instrument levels so that the test can be easily monitored. Please note that these levels are very different from the levels stipulated by test specification TS 25.141.

If you change to another test, click the *Configure* button to set appropriate new demo levels.

For the transmitter test *Power Control Steps*, the activated checkbox makes the SMIQ simulate the downlink signal of the base station. If the checkbox is deactivated, the SMIQ will generate an uplink signal to control the output power of the DUT.

For the uplink signals of chapter *Test signals only*, an activated *Signal Settings Demo* checkbox switches the SMIQ to trigger free run and internal

10 MHz reference. If deactivated, trigger and reference are set to external to synchronize with the base station.

Break:

Clicking this button breaks a running test. However, as SMIQ always finishes a current configuration, the break is not necessarily instantaneous.

To get familiar with the program, connect the output of your SMIQ generator to the input of your FSIQ analyzer, and run some tests.

Advanced information about the demo program

Remote control:

You can disable the program control for one or both instruments with the remote control checkboxes on the user panel (see Fig. 2). The entry fields for frequency and level disappear.

- For simulation of the base station tests, the control for FSIQ and SMIQ has to be switched on.
- For transmitter tests on a base station, switch the remote control of SMIQ off.
- For BER measurements switch the remote control of FSIQ off.

See the sections *Transmitter*, *Receiver*, and *Performance Tests* for more information.

Synchronizing SMIQ and FSIQ:

If the *Configure* button is clicked, the connected instruments are reset first. This switches the SMIQ generator to internal reference, whereas the reference setting of the FSIQ analyzer is not affected.

To synchronize the generator and the analyzer, connect the 10 MHz ports of the instruments to each other and switch the FSIQ to external reference (Hardkey SETUP, Softkey REFERENCE INT / EXT).

Program Version:

The version of the demo program, and the version of the test specification (TS 25.141) the program applies to, are shown in the lower left corner of the user panel (Fig. 2).

Modifying tests:

The demo program is supplied with its source code. It is written using LabWindows CVI. To modify the code and generate a version of your own, you need the LabWindows CVI software from National Instruments (Rev. 5.5 or higher).

The transmitter tests are contained in the file `t_tests.c`, the receiver tests in the file `r_tests.c`, the performance tests in the file `p_tests.c`, and the generation of the test signals in the file `test_sigs.c`. Edit these files to change or add remote control commands, or to modify the test sequence.

For the configuration of the downlink and uplink signals, see the file `signals.c`.

The other program files control the user interface, the program flow, and the remote control.

After code modifications, recompile the program and build a new version.

Uncertainty of the complete test system

For the complete test set up, you need additional components, such as power attenuators, cables, couplers and filters. Because they all have some impact on the test results, no *PASS / FAIL* verdict is given by the demo program.

Note: Enter your external attenuation on the FSIQ analyzer as reference level offset (Hardkey REF, Softkey REF LEVEL OFFSET) after the configuration of the instrument.

4 .

Left intentionally free.

5 .

Left intentionally free.

6 Transmitter Tests

Transmitter tests are measurements on the base station downlink signal, the base station transmitter is active. For the downlink, TS 25.141 specifies four different test signals, the test models, to make sure that measurement results from different base stations can be compared.

Table 1 gives a summary of the transmitter tests stipulated by TS 25.141.

No.	Test	Measurement	TM
6.2	Base station output power		
6.2.1	Base station maximum output power	mean power of one carrier	1
6.2.2	CPICH power accuracy	code domain power	2
6.3	Frequency error		
		actual BS transmit frequency	(4)
6.4	Output power dynamics		
6.4.2	Power control steps	code domain power	2
6.4.3	Power control dynamic range	code domain power	2
6.4.4	Total power dynamic range	mean power of one carrier	4
6.5	Output RF spectrum emissions		
6.5.1	Occupied bandwidth	spectrum	1
6.5.2	Out of band emission		
6.5.2.1	Spectrum emission mask	spectrum	1
6.5.2.2	Adjacent channel leakage ratio	spectrum	1
6.5.3	Spurious emissions		
6.5.3.4.1	Spurious emissions Category A	spectrum	-
6.5.3.4.2	Spurious emissions Category B	spectrum	-
6.5.3.4.3	Protection of the BS receiver	spectrum	-
6.5.3.4.4	Co-existence with GSM 900	spectrum	-
6.5.3.4.5	Co-existence with DCS 1800	spectrum	-
6.5.3.4.6	Co-existence with PHS	spectrum	-
6.5.3.4.7	Co-existence with adj. services	spectrum	-
6.5.3.4.8	Co-existence with UTRA-TDD	spectrum	-
6.6	Transmit intermodulation		
		as 6.5.2 / 3 + Interferer	1
6.7	Transmit modulation		
6.7.1	Error vector magnitude	result summary	4
6.7.2	Peak code domain error	result summary	3

Table 1: Summary of the transmitter tests

The left column of table 1 contains the number of the chapter in the test specification, the right one the test model that has to be used. All of these tests can be made with the FSIQ analyzer.

Test set up for transmitter tests

Figure 4 shows the general test set up for the transmitter tests.

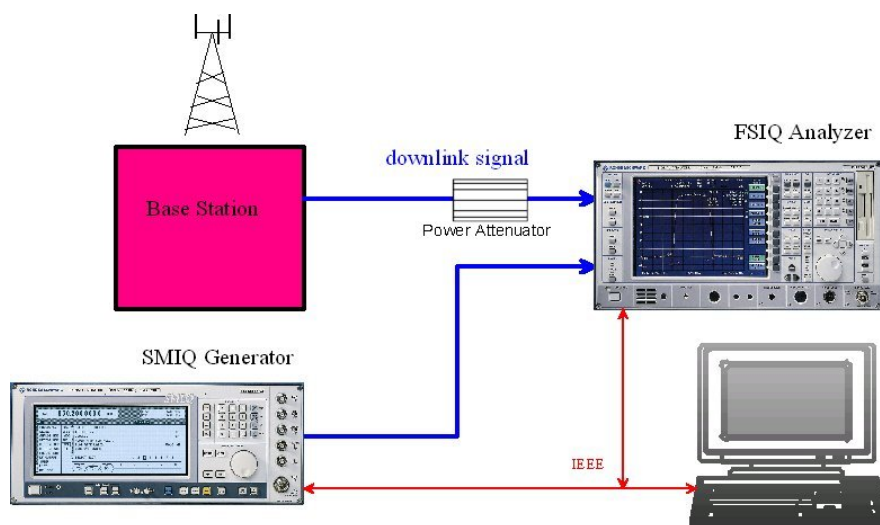

Fig. 4: General test set up for the transmitter tests

The signals from the base station TX port are recorded and analyzed by FSIQ.

Both the SMIQ generator and the FSIQ Analyzer are remote controlled by a PC running 3GDemoBS.

- Figure 4 only shows the principle test set up. For the actual measurement system set up for each test, see Appendix B of the test specification TS 25.141.
- Insert an attenuator (with sufficient attenuation) which can cope with the high power applied at the base station TX output. **The maximum input power at the FSIQ connector must not exceed + 30 dBm.**
- Enter the insertion loss between the base station and the analyzer as a reference level offset on the FSIQ. The analyzer will then display the levels from the RF port of the base station. Either enter the value manually after of the instruments have been configured, or, add the following IEEE command to the config routine of the respective test and recompile the program.

For example, for 50 dB ext. attenuation:

```
disp:tracel:y:rlevel:offset 50db
```

After this, recompile the program and build a new version.

If you simulate the base station with the SMIQ, it provides the required test model.

Transmitter tests step by step

1. Connect your DUT to the analyzer as described in TS 25.141. Insert an attenuator (with sufficient attenuation) between the base station TX output and the FSIQ analyzer.
2. Select the test from the demo program user panel.
3. If you do not need the generator, disable the SMIQ's control in the remote control checkbox. This speeds up the configuration.
4. Start the configuration by clicking the *Configure* button.

After clicking the *Configure* button, the connected instruments are reset. Reset switches the SMIQ to internal reference, whereas the FSIQ's reference setting will be not affected.

If remote control for the SMIQ generator is enabled, extensive calculation of the required test model inside the SMIQ takes place, which can take up to one minute.

While configuration of SMIQ or FSIQ is running, the *Configured* LEDs are yellow. When configuration is completed, the *Configured* LEDs go green.

The instruments are now correctly configured; the RF output of the SMIQ generator is still switched off.

5. Enter the insertion loss between the base station and the analyzer as a reference level offset on the FSIQ. This can be done manually, or, by adding the following IEEE command to the config routine of the respective test. For example, for a 50dB external attenuation

```
disp:tracel:y:rlevel:offset 50db
```

Do not forget to recompile the program and build a new executable.

6. Start the selected test by clicking the *Start* button.

Clicking the *Start* button switches the RF output of the SMIQ generator on and starts the analyzer. When the measurement is completed, results are displayed on the analyzer and in the *RESULTS* window.

While a test is running, the *Running* LEDs are green. When the measurement is completed, the *Running* LED of the analyzer goes out and the *Idle* LED lights.

The generator continues running.

Notes: For the transmitter tests, no changes of the instrument settings are performed by the demo program after clicking *Start*. So, you can repeat a measurement by clicking the *Start* button again without reconfiguring; you can modify the setting of the instruments manually between two starts, as required.

If you want to change to another test which still uses the same test model, to avoid a time consuming recalculation of the test model, disable the remote control of the generator before clicking the *Configure* button.

After a test, check whether an underflow or overflow has occurred. Both will be indicated on the analyzer's screen.

The input attenuation of the FSIQ is set to auto by default. For best results, adjust it manually to achieve the optimum

(rms) mixer level of -12 dBm. (The mixer level equals the input level minus the input attenuation.)

For basic information about the transmitter tests with FSIQ, see the application note 1EF44 [6] available from the Rohde & Schwarz website.

Base station maximum output power (6.2.1)

Maximum output power, P_{max} , of the base station is the mean power level per carrier measured at the antenna connector.

The test purpose is to verify the accuracy of the maximum output power across the frequency range and under normal and extreme conditions for all transmitters in the base station.

- For measurements on a base station, disable the remote control of SMIQ from the 3GDemoBS user panel. Insert an attenuator (with sufficient attenuation) which can cope with the high power applied at the base station TX output.
- For simulation, connect SMIQ output to the input of the FSIQ, and activate Signal Settings Demo on the 3GDemoBS user panel. The level of SMIQ will be set to -20 dBm.

Test procedure on a base station:

1. Set the DUT to transmit a signal modulated with the channel combination of test model 1.
2. From the 3GDemoBS user panel select test 6.2.1 Base station maximum output power.
3. Enter *Frequency* and *Levels*.
4. Configure the test set up by clicking the *Configure* button.
5. When the configuration is completed, enter your external attenuation on the FSIQ analyzer (Hardkey REF, Softkey REF LEVEL OFFSET).
6. Start the test by clicking the *Start* button on the user panel.
7. Check results in the *RESULTS* window.

Test results:

In normal conditions, the Base station maximum output power shall remain within $+2.0$ dB and -2.0 dB of the manufacturer's rated output power.

In extreme conditions, the Base station maximum output power shall remain within $+2.5$ dB and -2.5 dB of the manufacturer's rated output power.

Fig. 5 shows a measurement result displayed on the analyzer. The power of the test signal was set to -20 dBm; cables and connectors caused additional loss.

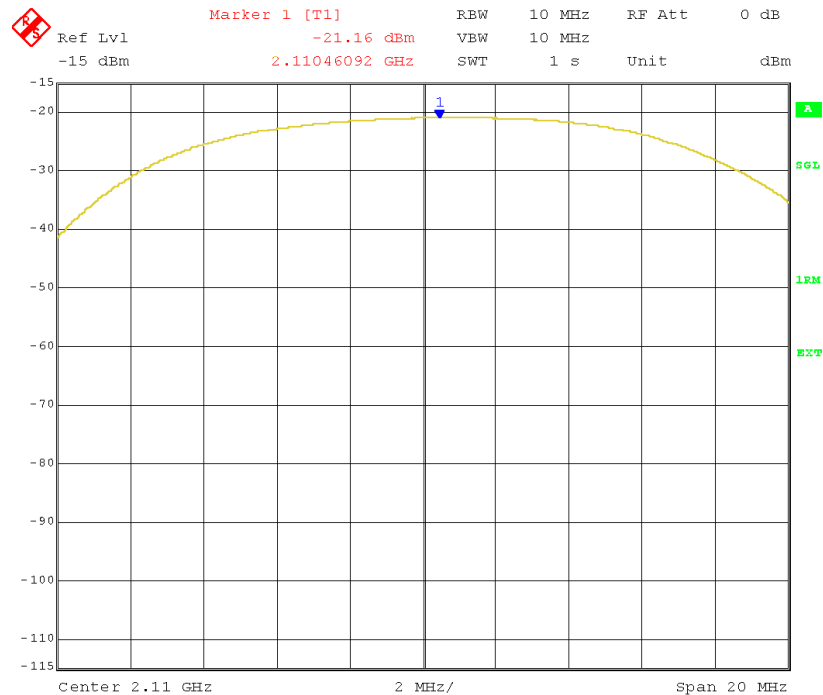

Fig. 5: Base station maximum output power: results displayed on the analyzer

CPICH power accuracy (6.2.2)

CPICH power accuracy is defined as the maximum deviation between the ordered channel power and the power in that channel measured at the TX antenna interface.

The purpose of the test is to verify that the base station under test delivers CPICH power within margins.

- For measurements on a base station, disable the remote control of SMIQ from the 3GDemoBS user panel. Insert an attenuator (with sufficient attenuation) which can cope with the high power applied at the base station TX output.
- For simulation, connect SMIQ output to the input of the FSIQ, and activate Signal Settings Demo on the 3GDemoBS user panel. The total output power of SMIQ will be set to -20 dBm. For the test model 2 used here, the levels of CPICH and CCPCH have to be 10 dB lower.

Test procedure on a base station:

1. Disable inner loop power control at the base station.
2. Set up the base station to transmit at maximum total power as specified by the supplier.
3. Set up the base station to transmit a signal modulated with the channel combination of test model 2.
4. From the 3GDemoBS user panel select test 6.2.2 CPICH power accuracy.
5. Enter *Frequency* and *Levels*.
6. Configure the test set up by clicking the *Configure* button.
7. When the configuration is completed, enter your external attenuation on the FSIQ analyzer (Hardkey REF, Softkey REF LEVEL OFFSET).
8. Start the test by clicking the *Start* button.
9. Check results in the *RESULTS* window.

Test results:

In normal conditions, the measurement results shall remain within +2.7 dB and -2.7 dB of the manufacturer's rated output power.

In extreme conditions, measurement results shall remain within +3.2 dB and -3.2 dB of the manufacturer's rated output power.

Fig. 6 shows the result output from the demo program, Fig. 7 the result displayed on the analyzer. The total power of the test signal was set to -20 dBm. CPICH and CCPCH have to be 10 dB lower; cables and connectors caused additional loss.

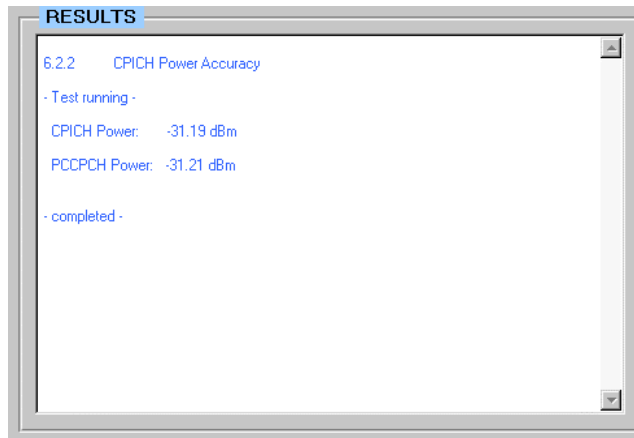

Fig. 6: CPICH power accuracy: results output from the demo program

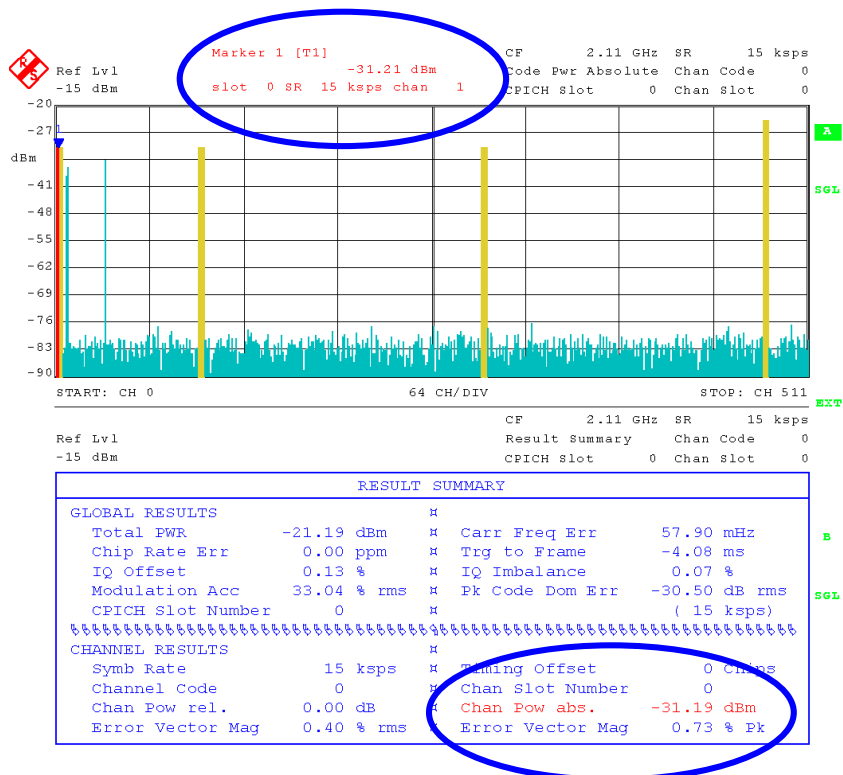

Fig. 7: CPICH power accuracy: results displayed on the analyzer

Frequency error (6.3)

Frequency error is the measure of the difference between the actual BS transmit frequency and the assigned frequency.

- For measurements on a base station, disable the remote control of SMIQ from the 3GDemoBS user panel. Insert an attenuator (with sufficient attenuation) which can cope with the high power applied at the base station TX output.
- To achieve sufficient accuracy to meet the requirements for this test, you need a high precision external reference for FSIQ, such as a Rubidium or a Cesium standard.
- For simulation, connect SMIQ output to the input of the FSIQ, and activate Signal Settings Demo on the 3GDemoBS user panel.

Test procedure on a base station:

1. Set up the base station to transmit at a total power of $P_{max} - 3$ dB.
2. Set up the base station to transmit a signal modulated with the channel combination of test model 4.
3. Connect a high precision external reference to FSIQ.
4. Set FSIQ to external reference (Hardkey SETUP, Softkey REFERENCE INT / EXT).
5. From the 3GDemoBS user panel select test 6.3 Frequency error.
6. Enter *Frequency and Levels*.
7. Configure the test set up by clicking the *Configure* button.
8. Start the test by clicking the *Start* button.
9. Check results in the *RESULTS* window.
10. Repeat the test with total power of $P_{max} - 18$ dB.

Test results:

The Frequency Error shall be within the range (-0.05 PPM – 12 Hz) to ($+0.05$ PPM + 12 Hz).

Fig. 8 shows the result output from the demo program, Fig. 9 the result displayed on the analyzer.

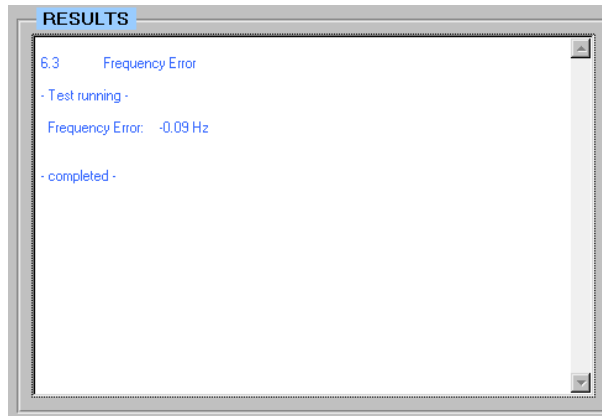

Fig. 8: Frequency error: results output of the demo program

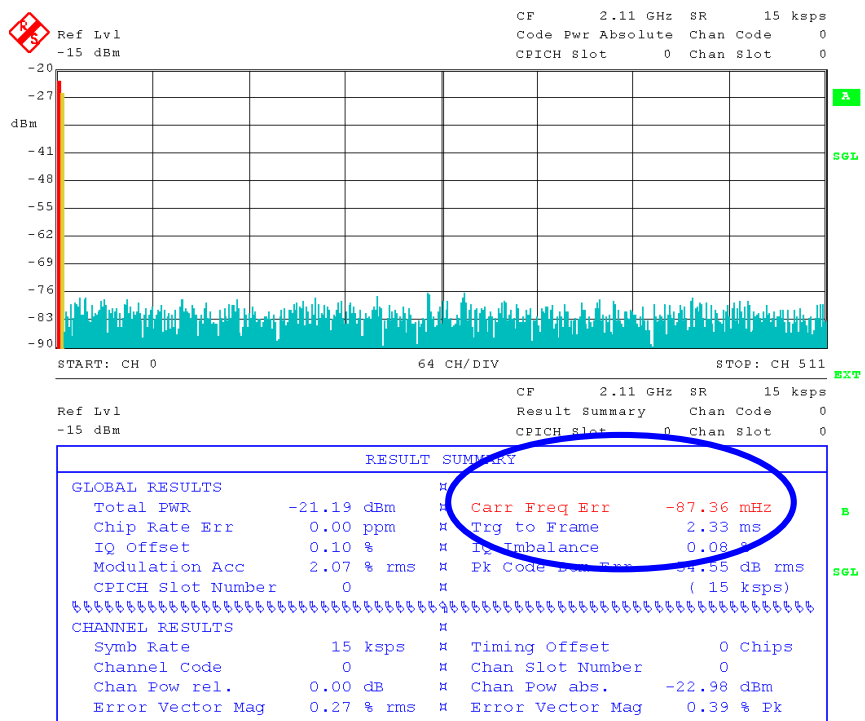

Fig. 9: Frequency error: results displayed on the analyzer

Power control steps (6.4.2)

This test measures the power control step and the combined output power change.

The power control step is the required step change in the downlink transmitter output power of a code channel in response to the corresponding power control command. The combined output power change is the required total change in the downlink transmitter output power of a code channel in response to multiple consecutive power control commands corresponding to that code channel.

For this test, a user equipment simulator or uplink generator has to set and send alternating TPC bits in the uplink signal to the base station to control the power of the downlink signal for one channel. The FSIQ as a code domain analyzer evaluates the power changes versus time.

With 3GDemoBS, the setting of the checkbox *Signal Settings Demo* defines whether the SMIQ shall play either the role of the uplink generator, or simulate the downlink signal of a base station.

- To simulate the downlink signal, activate the checkbox *Signal Settings Demo*.
- To generate the uplink signal, deactivate the checkbox *Signal Settings Demo*.

SMIQ generating an uplink signal:

The slot and frame timing of the uplink signal must be fitted to the slot and frame timing of the base station playing the role of a master, and providing trigger and 10 MHz reference signals for the SMIQ generator.

A suitable trigger is for example a signal indicating the Super Frame Number (SFN) restart which is output by most of the base stations. A trigger input for the SFN signal is available at the PAR DATA connector on the rear panel of the SMIQ generator.

Use an SMIQ-Z5 adapter which provides BNC connectors for all pins of the PAR DATA connector.

1. Connect the 10 MHz reference signal of the base station to the REF connector on SMIQ's rear panel.
2. Connect the SFN restart signal of the base station to the TRIG IN pin of the PAR DATA port.
3. Connect FSIQ - inserting an attenuator (with sufficient attenuation) - to the base station TX port.
4. Start base station transmission with channel configuration of test model 2.
5. Establish downlink power control.
6. From the 3GDemoBS user panel select test 6.4.2 Power control steps.
7. Disable the checkbox *Signal Settings Demo*.
8. Enter *Frequency* and *Levels*.
9. Configure the test set up by clicking the *Configure* button.

Tests on 3G - Base Stations

10. When the configuration is completed, enter your external attenuation on the FSIQ analyzer (Hardkey REF, Softkey REF LEVEL OFFSET).
11. Start the test by clicking the *Start* button.
12. Check the power steps on the analyzer.

Note: For further details on synchronizing SMIQ and base station, download the application note 1GP41 [6] from the Rohde & Schwarz website.

SMIQ simulating the downlink signal:

1. Connect SMIQ output to the input of the FSIQ.
2. From the 3GDemoBS user panel select test 6.4.2 Power control steps.
3. Activate the checkbox *Signal Settings Demo*.
4. Enter *Frequencies*.
5. Configure the instruments by clicking the *Configure* button.
6. Start the test by clicking the *Start* button.
7. Check power steps on the analyzer.

Test results:

Test 6.4.2 consists of two parts. Part a) uses alternating TPC bits to check the single power steps, part b) uses 10 consecutive equal steps to measure the combined output tolerance.

Fig.10 shows the result output of 3GDemoBS for 10 1dB-steps, Fig. 11 the result displayed on the analyzer.

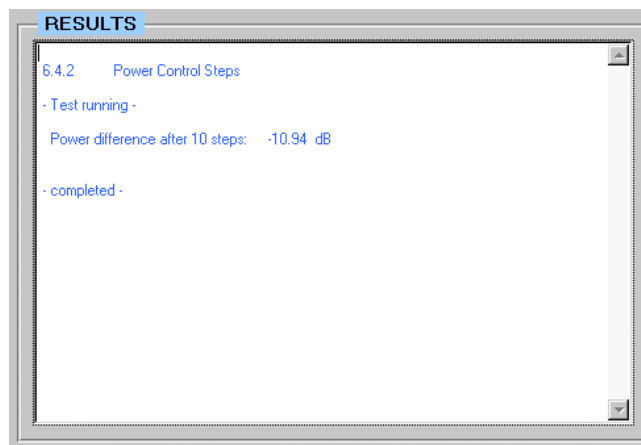

Fig. 10: Power control steps: output from the demo program

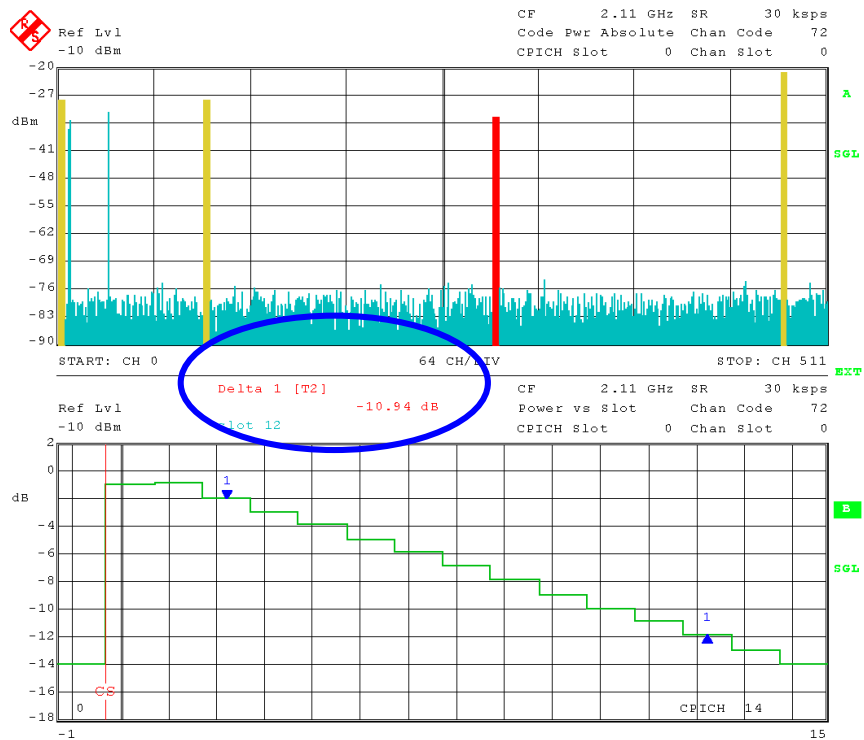

Fig. 11: Power control steps: result displayed on the analyzer

Power control dynamic range (6.4.3)

The power control dynamic range is the difference between the maximum and the minimum transmit output power of one code channel for a specified reference condition. So, this test comprises two measurements.

- For measurements on a base station, disable the remote control of SMIQ from the 3GDemoBS user panel. Insert an attenuator (with sufficient attenuation) which can cope with the high power applied at the base station TX output.
- For simulation, connect SMIQ output to the input of the FSIQ, and activate Signal Settings Demo on the 3GDemoBS user panel. The total output power of SMIQ will be set to -20 dBm. The level of the DPCH used here has to be 3 dB lower.

Test procedure on a base station:

1. Use the channel configuration of Test model 2.
2. Set the power of the DPCH under test to $P_{max} - 3$ dB. Adjust power levels for other code channels as necessary.
3. From the 3GDemoBS user panel, select test 6.4.3 Power control dynamic range.
4. Enter *Frequency* and *Levels*.
5. Configure the test set up by clicking the *Configure* button.
6. When the configuration is completed, enter your external attenuation on the FSIQ analyzer (Hardkey REF, SoftkeyREF LEVEL OFFSET).
7. Start the test by clicking the *Start* button.
8. Check results in the *RESULTS* window.
9. Set power of the DPCH under test to the minimum value by means determined by the manufacturer. Power levels for other code channels shall remain unchanged.
10. Repeat the measurement.

Test results:

The maximum power shall be $P_{max} - 3.2$ dB or greater; the minimum power shall be $P_{max} - 27.8$ dB or less.

Fig.12 shows the result output from the demo program, Fig. 13 the result displayed on the analyzer. The total power of the test signal was set to -20 dBm, the DPCH to 3 dB lower. Cables and connectors caused additional loss.

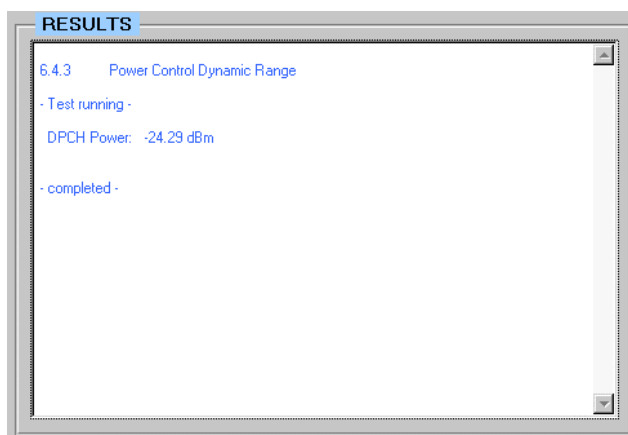

Fig. 12: Power control dynamic range: output from the demo program

Tests on 3G - Base Stations

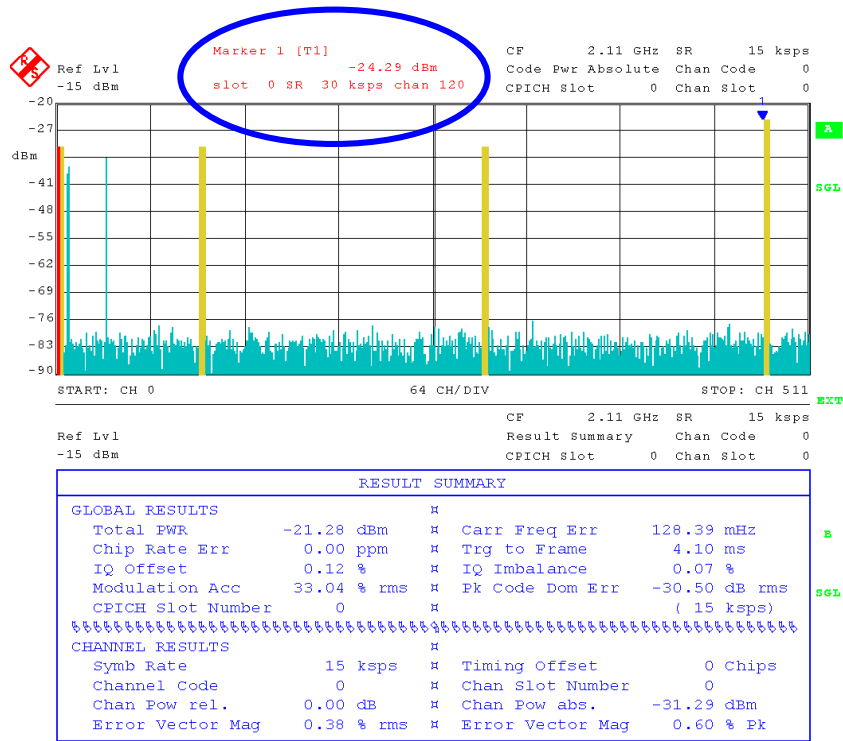

Fig. 13: Power control dynamic range: result displayed on the analyzer

Total power dynamic range (6.4.4)

The total power dynamic range is the difference between the maximum and the minimum transmit output power for a specified reference condition. This test is to ensure that the total output power can be reduced while still transmitting a single code.

This test is carried out together with *Error vector magnitude* test 6.7.1.

- For measurements on a base station, disable the remote control of SMIQ from the 3GDemoBS user panel. Insert an attenuator (with sufficient attenuation) which can cope with the high power applied at the base station TX output.
- For simulation, connect SMIQ output to the input of the FSIQ, and activate Signal Settings Demo on the 3GDemoBS user panel. The total output power of SMIQ will be set to -20 dBm.

Test procedure on a base station:

1. Set the base station to transmit a signal according to test model 4.
2. Set total power at the RF output port of the base station to Pmax-3dB
3. From the 3GDemoBS user panel select test 6.4.4 Total power dynamic range.
4. Enter *Frequency and Levels*.
5. Configure the test set up by clicking the *Configure* button.
6. When the configuration is completed, enter your external attenuation on the FSIQ analyzer manually (Hardkey REF, Softkey REF LEVEL OFFSET).
7. Start the test by clicking the *Start* button.
8. Check the Error Vector Magnitude in the *RESULTS* window.
9. Set total power at the RF output port of the base station to Pmax-18dB
10. Repeat the measurement.

Test results:

The downlink total power dynamic range shall be 17.7 dB or greater.

Fig.14 shows the result output from the demo program, Fig. 15 the result displayed on the analyzer. The power of the test signal was set to -20 dBm, cables and connectors caused additional loss.

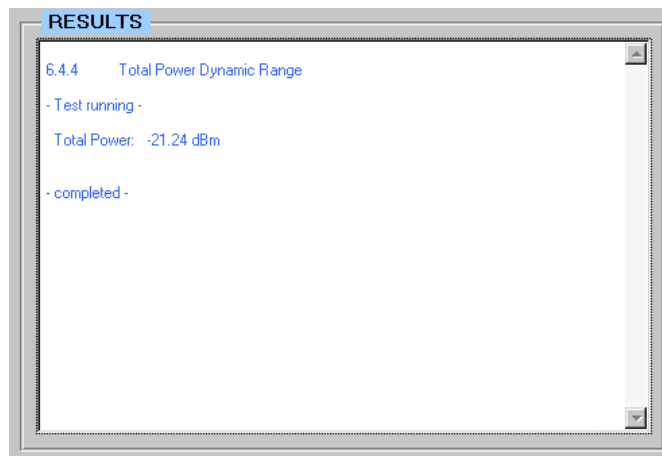

Fig. 14: Total power dynamic range: output from the demo program

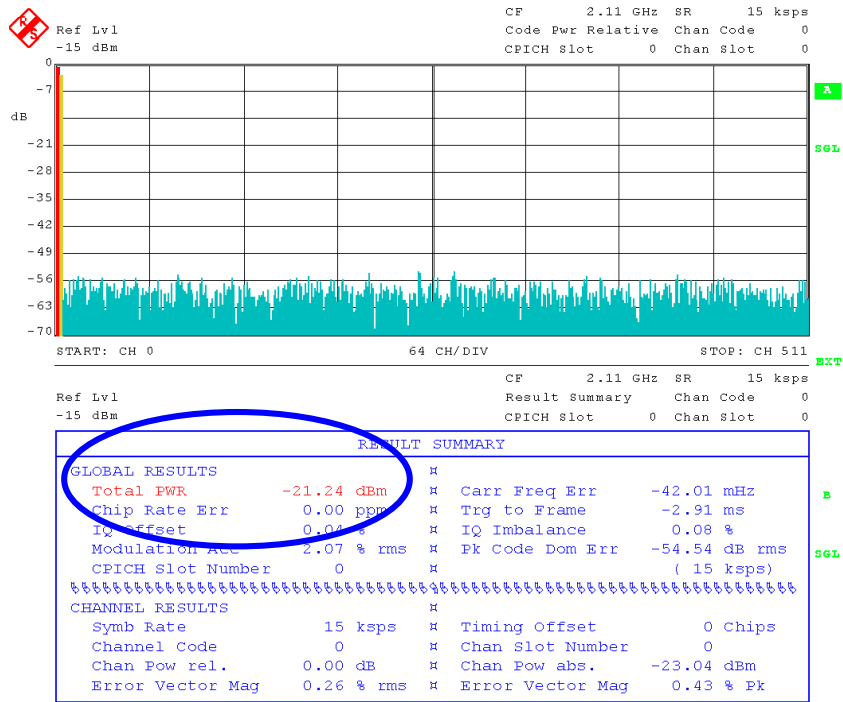

Fig. 15: Total power dynamic range: result displayed on the analyzer

Occupied bandwidth (6.5.1)

The occupied bandwidth is the width of a frequency band such that, below the lower and above the upper frequency limits, the mean powers emitted are each equal to 0.5% of the total mean transmitted power.

- For measurements on a base station, disable the remote control of SMIQ from the 3GDemoBS user panel. Insert an attenuator (with sufficient attenuation) which can cope with the high power applied at the base station TX output.
- For simulation, connect SMIQ output to the input of the FSIQ, and activate Signal Settings Demo on the 3GDemoBS user panel.

Test procedure on a base station:

1. Start transmission of a single carrier according to test model 1.
2. From the 3GDemoBS user panel select test 6.4.5 Occupied bandwidth.
3. Enter *Frequency* and *Levels*.
4. Configure the test set up by clicking the *Configure* button.
5. Start the test by clicking the *Start* button.
6. Check the occupied bandwidth in the *RESULTS* window.

Test results:

The occupied bandwidth shall be less than 5 MHz.

Fig. 16 shows the result output from the demo program, Fig. 17 the result displayed on the analyzer.

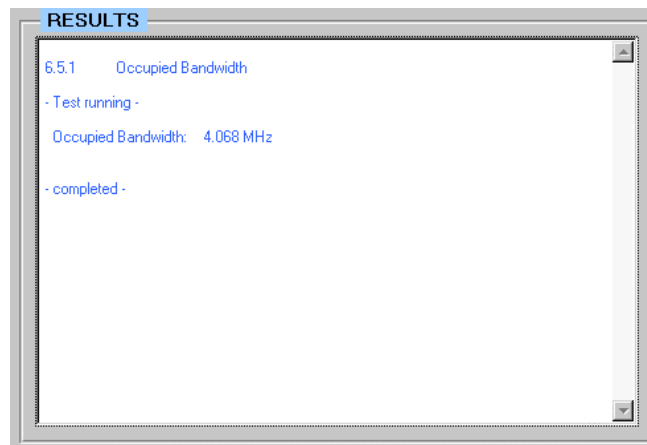

Fig. 16: Occupied bandwidth: output from the demo program

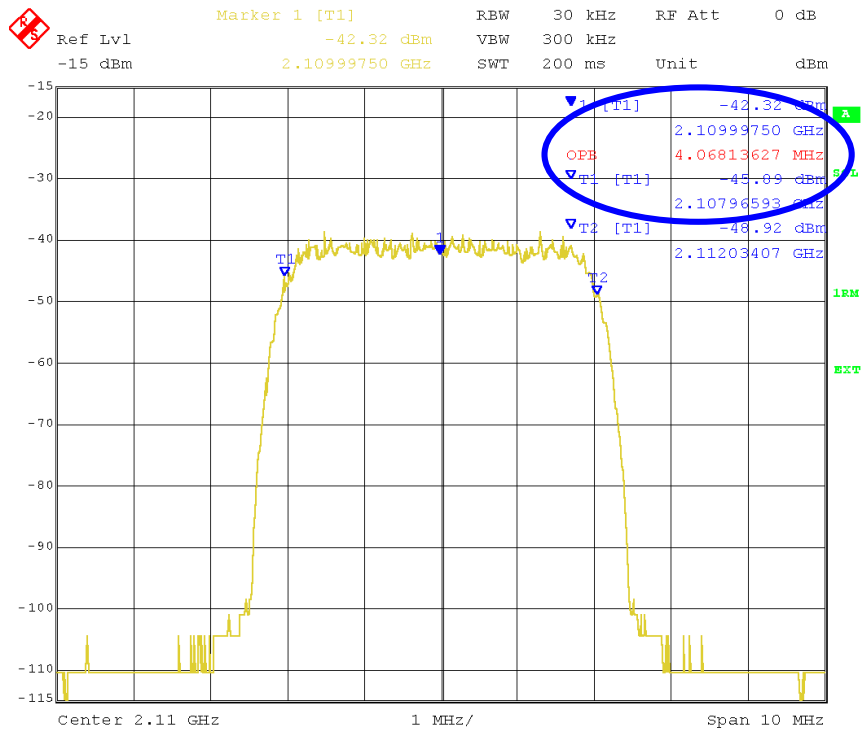

Fig. 17: Occupied bandwidth: result displayed on the analyzer

Spectrum emission mask (6.5.2.1)

This test measures the emissions of the base station, close to the assigned channel band, while the transmitter is in operation.

The out of band emission limit is defined for this test in terms of spectrum emission masks specified for different output power values.

Measurements are made with an offset from the carrier center frequency. This offset is either 12.5 MHz or the offset to the UMTS TX band edge, whichever is greater. The demo program analyzes a span of +/- 12.5 MHz around the carrier frequency.

Measurements with an offset from the carrier center frequency between 2,515 MHz and 4.0 MHz shall use a 30 kHz measurement bandwidth.

Measurements with an offset from the carrier center frequency between 4.0 MHz and (f_offsetmax - 500 kHz) shall use a 1 MHz measurement bandwidth. The 1MHz measurement bandwidth may be calculated by integrating multiple 50 kHz or narrower filter measurements. This so-called Integrated Bandwidth method is used inside the FSIQ.

Tests on 3G - Base Stations

- For measurements on a base station, disable the remote control of SMIQ from the 3GDemoBS user panel. Insert an attenuator (with sufficient attenuation) which can cope with the high power applied at the base station TX output.
- In addition, insert a notch filter between the base station and the analyzer to attenuate the carrier signal.
- For simulation, connect SMIQ output to the input of the FSIQ, and activate Signal Settings Demo on the 3GDemoBS user panel.

Test procedure on a base station:

1. Start transmission of a single carrier according to test model 1.
2. From the 3GDemoBS user panel select test 6.5.2.1 Spectrum emission mask.
3. Enter *Frequency and Levels*.
4. Configure the test setup by clicking the *Configure* button.
5. When the configuration is completed, enter your external attenuation on the FSIQ analyzer manually (Hardkey REF, SoftkeyREF LEVEL OFFSET).
6. Start the test by clicking the *Start* button.
7. Check the result on the analyzer's screen.

Test results:

Limits are marked on the analyzer's screen as red lines (as in fig. 18). A limit check indicates whether limits are exceeded or not.

Fig. 18 shows the result displayed on the analyzer.

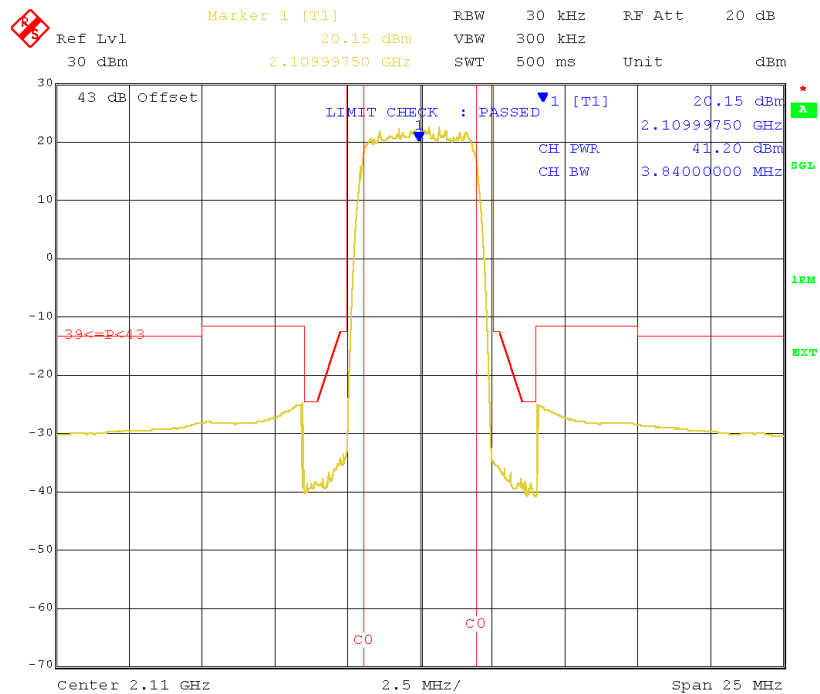

Fig. 18: Spectrum emission mask: result displayed on the analyzer

Adjacent Channel Leakage Power Ratio (6.5.2.2)

Adjacent Channel Leakage power Ratio (ACLR) is the ratio of the average power centered on the assigned channel frequency to the average power centered on an adjacent channel frequency.

- For measurements on a base station, disable the remote control of SMIQ from the 3GDemoBS user panel. Insert an attenuator (with sufficient attenuation) which can cope with the high power applied at the base station TX output.
- For simulation, connect SMIQ output to the input of the FSIQ, and activate Signal Settings Demo on the 3GDemoBS user panel. If SMIQ-B47 / Low ACP for CDMA and WCDMA is available, you can switch it to low error vector magnitude (after configuration of the instrument) for minimum noise in the alternate channels:

WCDMA/3GPP, FILTER, FILTER MODE LOW_EVM

Tests on 3G - Base Stations

The default program setting is for best results in the adjacent channels:
WCDMA/3GPP, FILTER, FILTER MODE LOW_ACP

Test procedure on a base station:

1. Start transmission of a single carrier according to test model 1.
2. Set the base station to maximum output power as specified by the manufacturer.
3. From the 3GDemoBS user panel select test 6.5.2.2 Adjacent Channel Leakage Power Ratio.
4. Enter *Frequency* and *Levels*.
5. Configure the test set up by clicking the *Configure* button.
6. When the configuration is completed, enter your external attenuation on the FSIQ analyzer (Hardkey REF, SoftkeyREF LEVEL OFFSET).
7. Start the test by clicking the *Start* button.
8. Check the result on the analyzer's screen.

Test results:

The ACLR of neighbour channels is displayed on the *RESULTS* window and on the analyzer's screen.

Fig. 19 shows the result output from the demo program, Fig. 20 the result displayed on the analyzer.

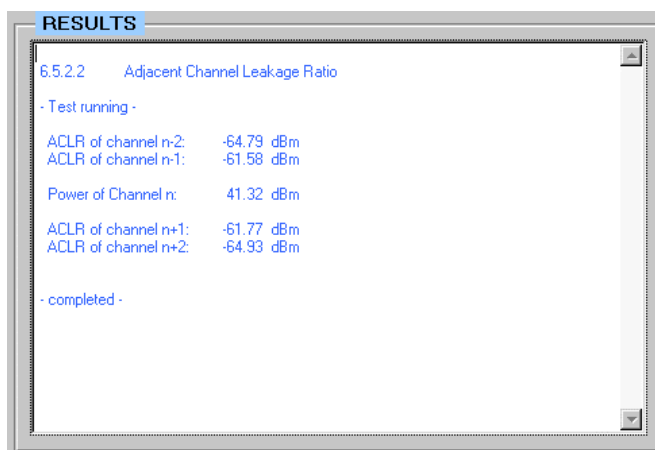

Fig. 19: Adjacent Channel Leakage Power Ratio: output from the demo program

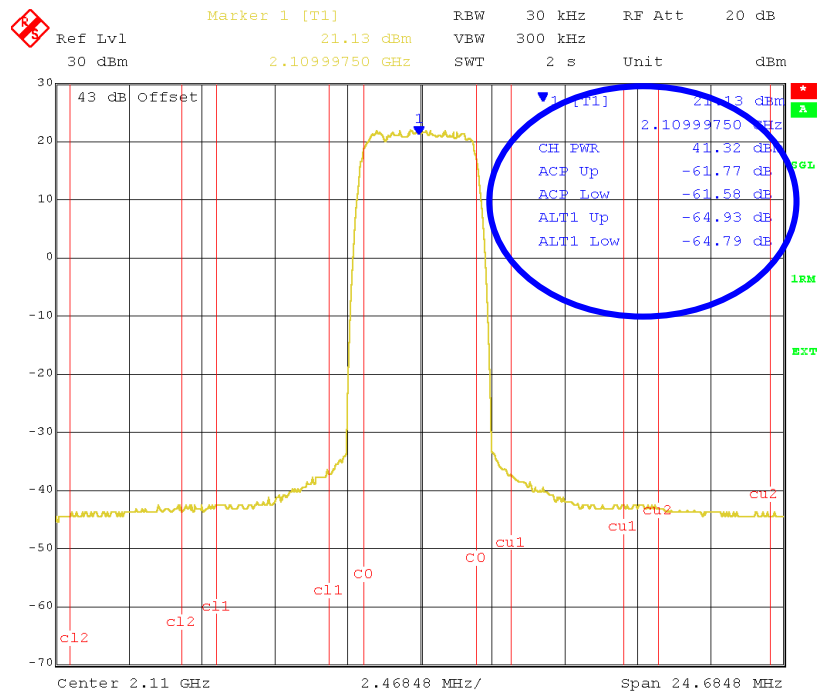

Fig. 19: Adjacent Channel Leakage Power Ratio: result displayed on the analyzer

Spurious emissions (6.5.3)

Spurious emissions are emissions which are caused by unwanted transmitter effects such as harmonics emission, parasitic emission, intermodulation products and frequency conversion products, but exclude out of band emissions. Spurious emissions are measured at the base station RF output port.

The requirement applies at frequencies within the specified frequency ranges, which are more than 12.5 MHz under the first carrier frequency used or more than 12.5 MHz above the last carrier frequency used.

The following test procedure applies for all spurious emission tests. To avoid an overload at the analyzer's input, for some of the tests you need an additional notch filter between the base station output and FSIQ, to suppress the carrier.

The demo program switches the SMIQ's RF output off.

- Insert an attenuator (with sufficient attenuation) which can cope with the high power applied at the base station TX output.

Test procedure on a base station:

1. If necessary, insert additional notch filters.
2. Start base station transmission.
3. From the 3GDemoBS user panel select the required test.
4. Enter the peak level at the analyzer's input as reference *Level* on the user panel.
5. Configure the test set up by clicking the *Configure* button.
6. When the configuration is completed, enter your external attenuation on the FSIQ analyzer (Hardkey REF, SoftkeyREF LEVEL OFFSET).
7. When the configuration is completed, carefully adjust the external attenuation on the FSIQ analyzer manually (Hardkey REF, Softkey RF ATTEN MANUAL) to achieve the best analyzer dynamic without overload, see the application note 1EF45 [7] available from the Rohde & Schwarz website.
8. Start the test by clicking the *Start* button.
9. If necessary, repeat steps 7 and 8.
10. Check the result in the *RESULTS* window against the requirements in the tests specification TS 25.141.

Spurious emissions Category A (6.5.3.4.1)

Fig. 20 shows the result output from the demo program.

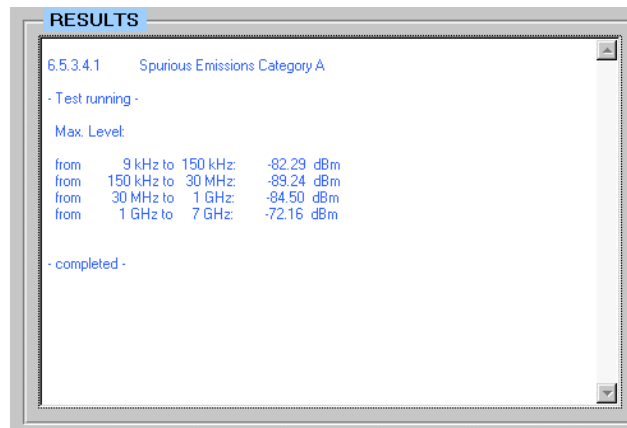

Fig. 20: Spurious emissions category A: output from the demo program

Spurious emissions Category B (6.5.3.4.2)

Fig. 21 shows the result output from the demo program.

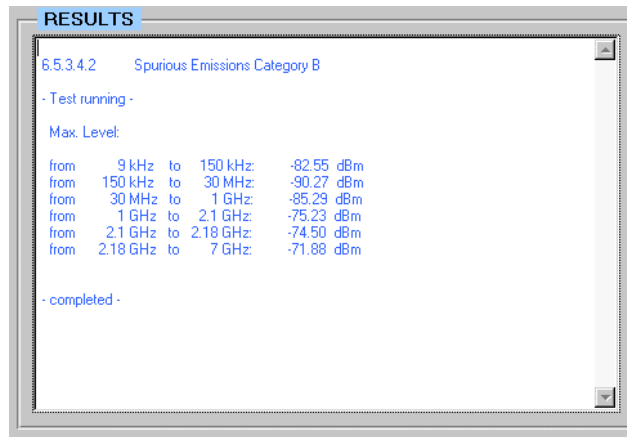

Fig. 21: Spurious emissions category B: output from the demo program

Protection of the base station receiver (6.5.3.4.3)

Fig. 22 shows the result output of the demo program.

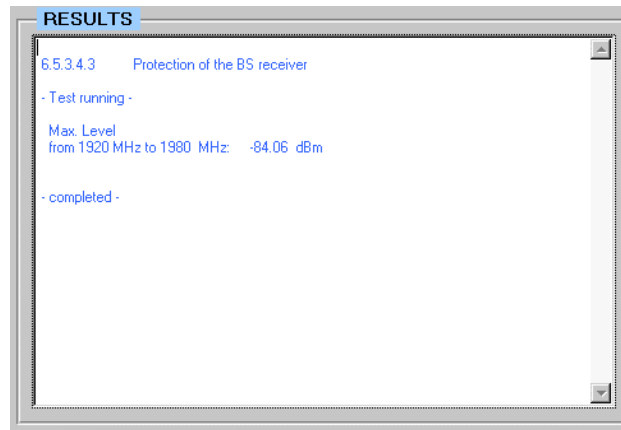

Fig. 22: Protection of the base station receiver: output from the demo program

Co-existence with GSM 900 (6.5.3.4.4)

Fig. 23 shows the result output from the demo program.

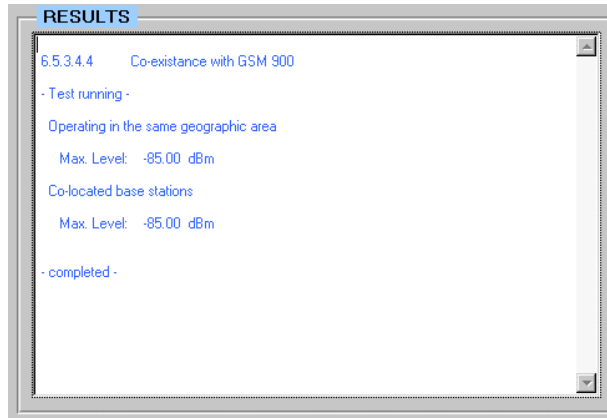

Fig. 23: Co-existence with GSM 900: output from the demo program

Co-existence with DCS 1800 (6.5.3.4.5)

Fig. 24 shows the result output from the demo program.

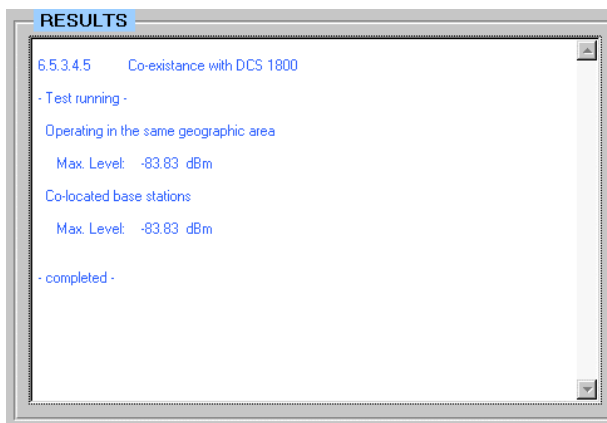

Fig. 24: Co-existence with DCS 1800: output from the demo program

Co-existence with PHS (6.5.3.4.6)

Fig. 25 shows the result output from the demo program.

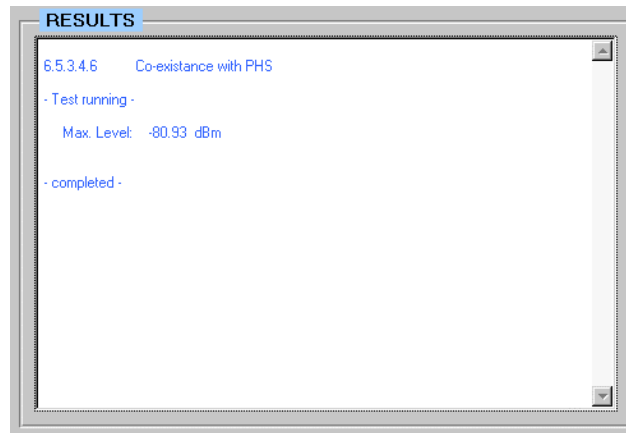

Fig. 25: Co-existence with PHS: output from the demo program

Co-existence with services in adjacent bands (6.5.3.4.7)

Fig. 26 shows the result output from the demo program.

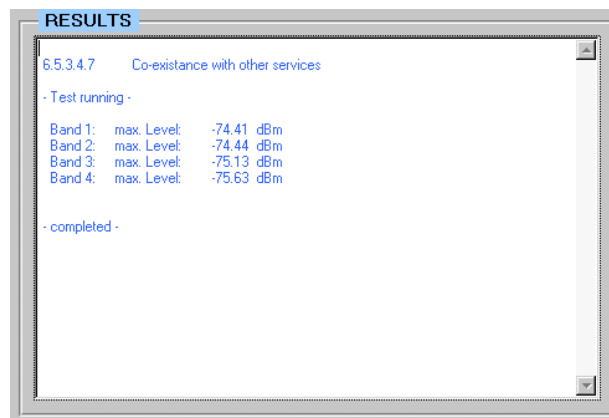

Fig. 26: Co-existence with other services: output from the demo program

Co-existence with UTRA-TDD (6.5.3.4.8)

Fig. 27 shows the result output from the demo program.

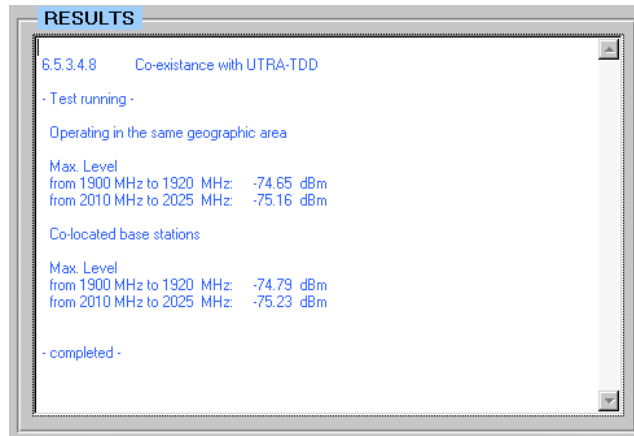

Fig. 27: Co-existence with UTRA-TDD: output from the demo program

Transmit intermodulation (6.6)

From the analyzer side, this test comprises the same tests as Out of band emission (6.5.2) and Spurious emissions (6.5.3), but in the presence of an interferer.

- Configure your system test set up according to chapter B.1.5 in the specification TS 25.141.
- Run tests 6.5.2 and 6.5.3.

Error Vector Magnitude (6.7.1)

The Error Vector Magnitude measures the difference between the reference waveform and the measured waveform. This difference is called the error vector. The measurement interval is one timeslot as defined by the CPICH (when present).

This test is the same as test 6.4.4 Total power dynamic range.

- For measurements on a base station, disable the remote control of SMIQ from the 3GDemoBS user panel. Insert an attenuator (with sufficient attenuation) which can cope with the high power applied at the base station TX output.
- For simulation, connect SMIQ output to the input of the FSIQ, and activate Signal Settings Demo on the 3GDemoBS user panel.

Test procedure on a base station:

1. Set the base station to transmit a signal according to test model 4.
2. Set total power at the RF output port of the base station to Pmax-3dB
3. From the 3GDemoBS user panel select test 6.7.1 Error vector magnitude.
4. Enter *Frequency* and *Levels*.
5. Configure the test set up by clicking the *Configure* button.
6. Start the test by clicking the *Start* button.
7. Check the Error Vector Magnitude in the *RESULTS* window.
8. Set total power at the RF output port of the base station to Pmax-18dB
9. Repeat the measurement.

Test results:

The Error Vector Magnitude shall be less than 17.5%

Fig. 28 shows the result output from the demo program, Fig. 29 the result displayed on the analyzer.

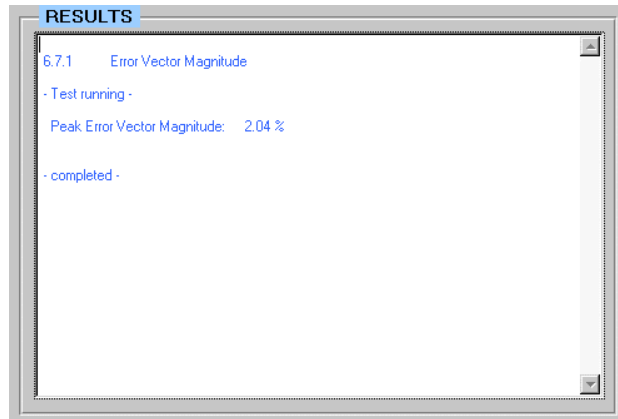

Fig. 28: Error Vector Magnitude: output from the demo program

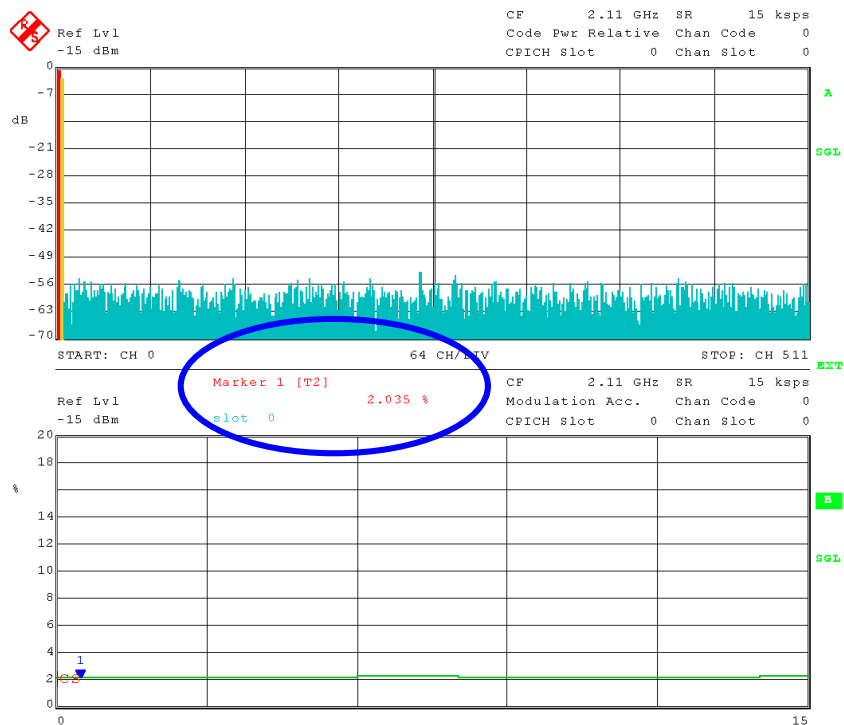

Fig. 29: Error Vector Magnitude: result displayed on the analyzer

Peak Code Domain Error (6.7.2)

The Peak Code Domain Error is computed by projecting the error vector (as defined in 6.7.1) onto the code domain at a specific spreading factor. The Code Domain Error for every code in the domain is defined as the ratio of the mean power of the projection onto that code, to the mean power of the composite reference waveform. This ratio is expressed in dB. The Peak Code Domain Error is defined as the maximum value for the Code Domain Error for all codes. The measurement interval is one timeslot as defined by the CPICH (when present).

- For measurements on a base station, disable the remote control of SMIQ from the 3GDemoBS user panel. Insert an attenuator (with sufficient attenuation) which can cope with the high power applied at the base station TX output.
- For simulation, connect SMIQ output to the input of the FSIQ, and activate Signal Settings Demo on the 3GDemoBS user panel.

Test procedure on a base station:

1. Set the base station to transmit a signal according to test model 3.
2. Set total power at the RF output port of the base station to Pmax-3dB
3. From the 3GDemoBS user panel select test 6.7.2
4. Enter *Frequency* and *Levels*.
5. Configure the test set up by clicking the *Configure* button.
6. Start the test set up by clicking the *Start* button.
7. Check the peak code domain error in the *RESULTS* window.
8. Set total power at the RF output port of the base station to Pmax-18dB
9. Repeat the measurement.

Test results:

The peak code domain error shall not exceed -33 dB at spreading factor 256.

Fig. 30 shows the result output from the demo program, Fig. 31 the result displayed on the analyzer.

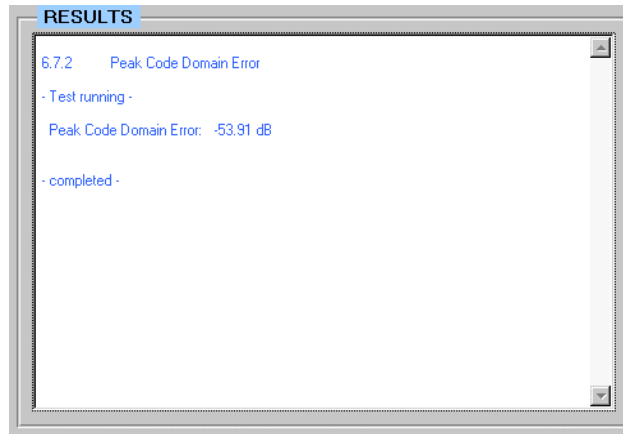

Fig.30: Peak Code Domain Error: output from the demo program

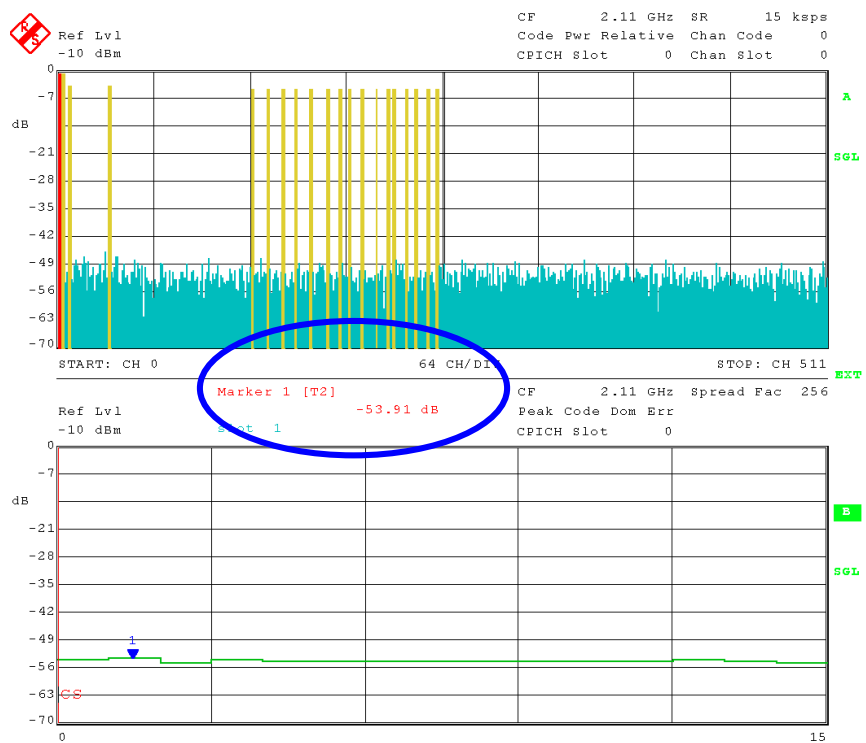

Fig.31: Peak Code Domain Error: result displayed on the analyzer

7 Receiver Tests

Receiver tests are bit error measurements on a 'wanted' signal without and with additional interferers. For the wanted signal, the TS 25.141 defines the so called Uplink Reference Measurement Channel (UL RMC) with a data rate of 12.2 kbps. A PRBS 9 sequence is used. The bit error rate is evaluated in the base station or with additional equipment connected to it, not in the test system.

Table 2 summarises the receiver tests stipulated by TS 25.141.

No.	Test	Measurement (BER)	UL RMC
7	Receiver Tests		
7.2	Reference sensitivity level	wanted signal only	12.2
7.3	Dynamic Range	+ interfering AWGN	12.2
7.4	Adjacent channel selectivity (ACS)	+ adjacent channel	12.2
7.5	Blocking Characteristics	+ 3GPP or CW interferer	12.2
7.6	Intermodulation characteristics	+ 3GPP and CW interferer	12.2
7.7	Spurious emissions	Spectrum	---
7.8	Verification of int. BER calculation	dirty signal	12.2

Table 2: Summary of the receiver tests

The left column of table 2 contains the number of the chapter in the test specification, the right one the uplink reference measurement channel that has to be used. For all of these tests, the wanted signal can be generated by the SMIQ. For interferers, you need additional generators.

Test Setup for Receiver tests

Figure 32 shows the general test set up for the receiver tests.

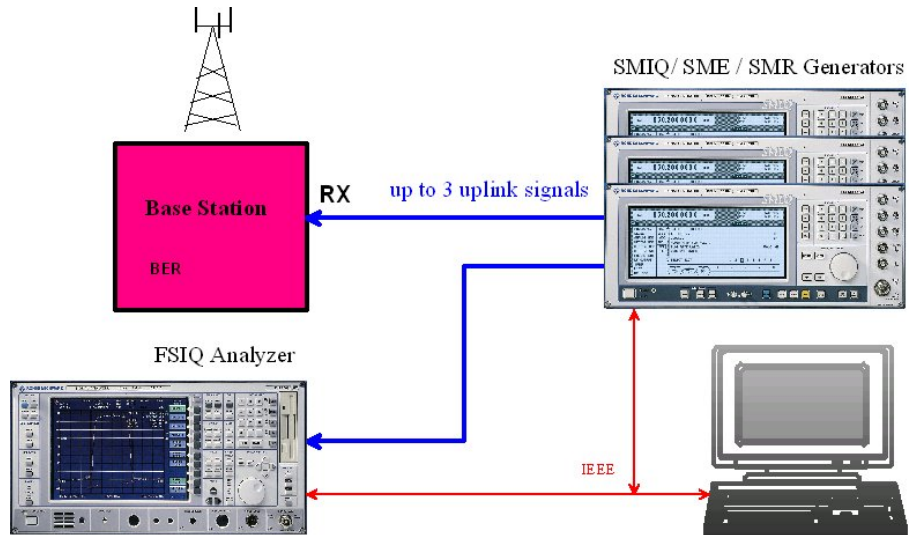

Figure 32: General test set up for the receiver tests

For the receiver tests 7.4 (Adjacent Channel Selectivity), 7.5 (Blocking Characteristics), and 7.6 (Intermodulation Characteristics) you need more than one generator. One SMIQ is in charge of generating the wanted signal. A second, interfering, signal could be provided by a second SMIQ. Test 7.5 additionally requires an interfering signal of up to 12.75 GHz which an SMR generator is able to provide. Couplers are needed to combine the output signals of the instruments.

Most receiver tests consist of many single measurements. Especially the Blocking characteristics test requires the same bit error measurement 10,000 times, each time with a different interfering frequency.

That is why the application program demonstrates only the principle of the receiver tests. It supports one SMIQ which generates the wanted signal first. After a short delay, the SMIQ will be configured a second time to provide the interfering signals. The FSIQ analyzer is programmed to record and display the wanted and interfering signals on one screen.

- **To generate a continuous uplink test signal for any of the receiver tests, select the test type *Test Signal Only* and activate the corresponding preprogrammed signal, see section 9 *Test Signals only* on page 63.**

Receiver Test Demonstration Step by Step

1. Select a test.
2. Start the configuration by clicking the *Configure* button.

Unlike the configuration for transmitter tests, clicking the *Configure* button causes only a few basic settings on the SMIQ. The reason for this is that the SMIQ has to be configured to generate several signals subsequently.

So that it only remains necessary to click *Configure* once, and can repeat a test by clicking *Start* again, the complete setup of the SMIQ including the calculation of the uplink reference measurement channel has been moved to the *Start* actions.

After clicking the *Configure* button, the connected instruments are reset, so that no inadvertent setting disturbs the test. Reset switches the SMIQ to internal reference, whereas the FSIQ's reference setting will be not affected.

The FSIQ – if present with remote control enabled – will be set up as required for the selected test. On the SMIQ, only frequency and level is set. The RF is switched off.

Note: If you do not need the analyzer, disable FSIQ control in the remote control checkbox. This speeds up the configuration.

3. Start the selected test by clicking the *Start* button.

Clicking the *Start* button sets up the SMIQ for the wanted signal and switches the RF output on. If the FSIQ analyzer is connected, and remote control enabled, a first result is recorded. Then the second signal is set up and recorded as a second trace by the analyzer, and so on. When the test is completed, all signals are displayed on the analyzer's screen.

The LEDs on the user panel indicate the status of the instruments.

Notes: The receiver tests according to TS 25.141 work with very low power levels. If you want to monitor these signals, you need a preamplifier for the analyzer. The Demo Signal Setting, however, is high enough to fit into the dynamic range of the FSIQ.

For more detailed information about the receiver tests with SMIQ, see the application note 1GP41 [6] available from the Rohde & Schwarz website.

For synchronisation of base station and SMIQ, see chapter 9 *Test Signals only* on page 63.

Reference Sensitivity Level (7.2)

The reference sensitivity is the minimum receiver input power measured at the antenna connector at which the BER does not exceed 0.001. This test is performed without an interfering signal.

- For measurements on a base station, disable the FSIQ remote control and Signal Settings Demo from the 3GDemoBS user panel.
- For simulation, connect the SMIQ output to the input of FSIQ, and activate Signal Settings Demo on the 3GDemoBS user panel.

Test procedure on a base station:

1. Set the base station frequency.
2. From the 3GDemoBS user panel select test 7.2 Reference Sensitivity Level.

Tests on 3G - Base Stations

3. Set *Frequency* of the SMIQ to the DUT uplink frequency.
4. Set *Level* of the SMIQ to a nominal value.
5. Configure the test set up by clicking the *Configure* button.
6. Start the test set up by clicking the *Start* button.
7. Calculate BER from at least 30,000 received data bits.
8. Set *Level* of the SMIQ to -121 dBm.
9. Measure BER.

Test results:

Fig.33 shows the signal displayed on the analyzer.

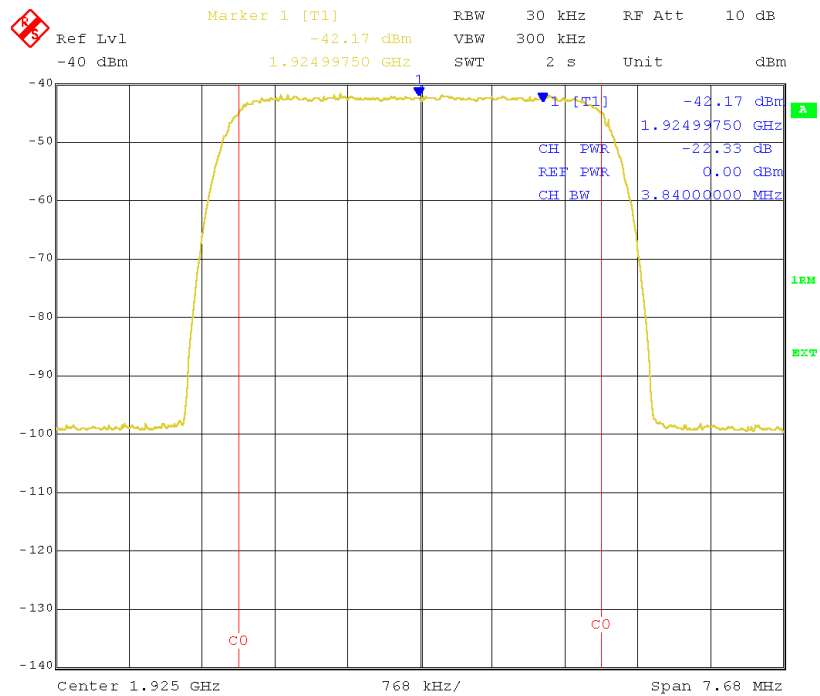

Fig. 33: Uplink signal for reference sensitivity level test

Dynamic Range (7.3)

Receiver dynamic range is the receiver's ability to handle a rise of interference in the reception frequency channel.

The test purpose is to verify the ability of the base station to receive a single-code test signal of -91 dBm in the presence of an interfering AWGN signal of -73 dBm / 3.84 MHz with a BER not exceeding 0.001.

Because the AWGN generator of the SMIQ uses a system bandwidth of two times 3.84 MHz for the demo program, the carrier / noise ratio has to be decreased by 3 dB:

$$-(91 \text{ dBm} - 73 \text{ dBm}) - 3 \text{ dBm} = -21 \text{ dBm}.$$

- For measurements on a base station, disable the FSIQ remote control and Signal Settings Demo from the 3GDemoBS user panel.
- For simulation, connect the SMIQ output to the input of FSIQ, and activate Signal Settings Demo on the 3GDemoBS user panel.

Test procedure on a base station:

1. Set the base station frequency.
2. From the 3GDemoBS user panel select test 7.3 Dynamic Range.
3. Set *Frequency* of the SMIQ to the DUT uplink frequency.
4. Set *Level* of the SMIQ to - 91 dBm.
5. Configure the test set up by clicking the *Configure* button.
6. Start the test by clicking the *Start* button.
7. Wait until the AWGN noise is switched on.
8. Measure BER.

Test results:

Fig. 34 shows the uplink signal without AWGN (below), and with AWGN (above).

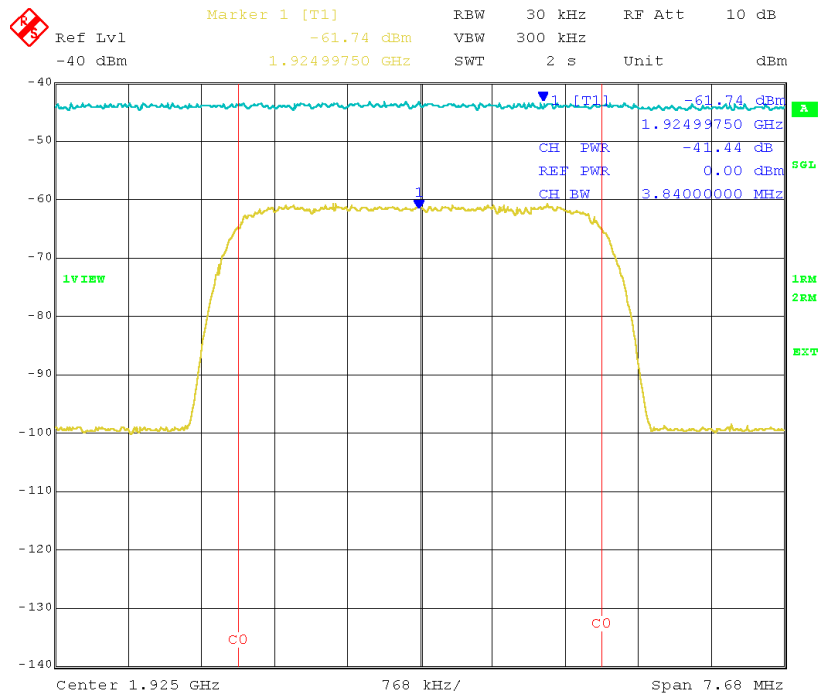

Fig. 34: Uplink signal for Dynamic Range test

Adjacent Channel Selectivity (7.4)

Adjacent Channel Selectivity (ACS) is a measure of the receiver ability to receive a wanted signal at its assigned channel frequency in the presence of an adjacent channel signal at a given frequency offset from the center frequency of the assigned channel.

3GDemoBS demonstrates only the principle of this test. It generates the wanted signal first. After a short delay, the SMIQ will be configured a second time to provide one interfering signal. The FSIQ analyzer is programmed to record and display the wanted and interfering signals on one screen.

- To generate a continuous wanted signal, select the test type *Test Signals Only* and activate the corresponding preprogrammed signal, see chapter 9 *Test Signals only* on page 63.
- To simulate testing without a base station, connect SMIQ output to the input of the FSIQ, activate *Signal Settings Demo* on the user panel of the 3GDemoBS program, and configure and start the test.

For demonstration:

1. From the 3GDemoBS user panel select test 7.4 Adjacent Channel Selectivity.

Tests on 3G - Base Stations

2. Activate *Signal Settings Demo*.
3. Configure the test set up by clicking the *Configure* button.
4. Start the test demo by clicking the *Start* button.

Fig. 35 shows the output from the demo program, Fig. 36 the signals displayed on the analyzer.

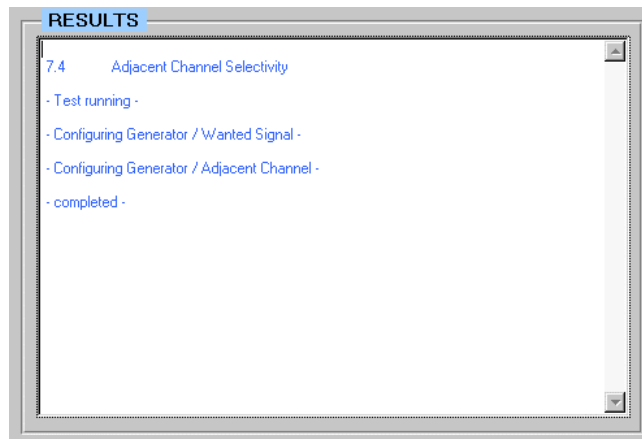

Fig. 35: Adjacent Channel Selectivity: output from the demo program

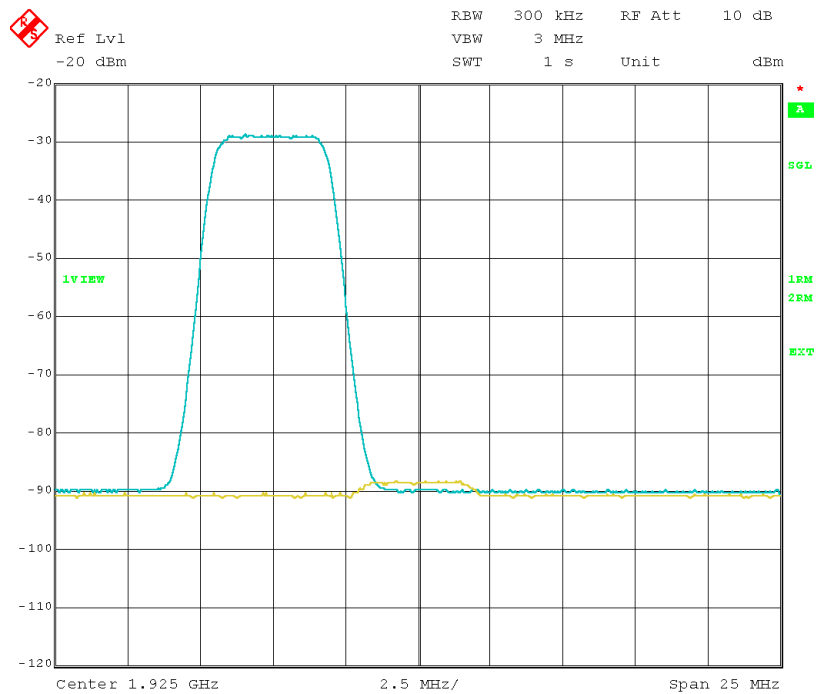

Fig. 36: Adjacent Channel Selectivity: wanted signal (at higher frequency) and adjacent channel (at lower frequency).

Blocking Characteristics (7.5)

The blocking characteristics is a measure of the receiver ability to receive a wanted signal at its assigned channel frequency in the presence of an unwanted interferer on frequencies other than those of the adjacent channels.

3GDemoBS demonstrates only the principle of this test. According to TS 25.141, you have to completely measure the Bit Error Rate BER at every 1 MHz increment in the range from 1 MHz to 12.7 GHz, using 1 MHz steps. This takes too long for a demo program.

This set up is for demonstration only. It generates the wanted signal first. After a short delay, the SMIQ will be configured a second time to provide one WCDMA interfering signal which has to be applied in a range from 20 MHz below the uplink band to a frequency 10 MHz below the wanted signal, and from 10 MHz above the wanted signal to 20 MHz above the uplink band. Afterwards, a second interferer (a CW signal) is generated in frequency range from 1 MHz to 20 MHz range below the uplink band, and up from 20 MHz above the uplink band.

The FSIQ analyzer is programmed to record and display the wanted and interfering signals on one screen.

- To generate a continuous wanted signal, select the test type *Test Signals Only* and activate the corresponding preprogrammed signal, see chapter 9 *Test Signals only* on page 63.
- To simulate testing without a base station, connect SMIQ output to the input of the FSIQ, activate *Signal Settings Demo* on the user panel of the 3GDemoBS program, and configure and start the test set up.

For demonstration:

1. Connect the SMIQ output to the FSIQ input port.
2. From the 3GDemoBS user panel select test 7.5 Blocking characteristics.
3. Activate *Signal Settings Demo*.
4. Configure the test set up by clicking the *Configure* button.
5. Start the test by clicking the *Start* button.

Fig. 37 shows the output from the demo program, Fig. 38 the signals displayed on the analyzer.

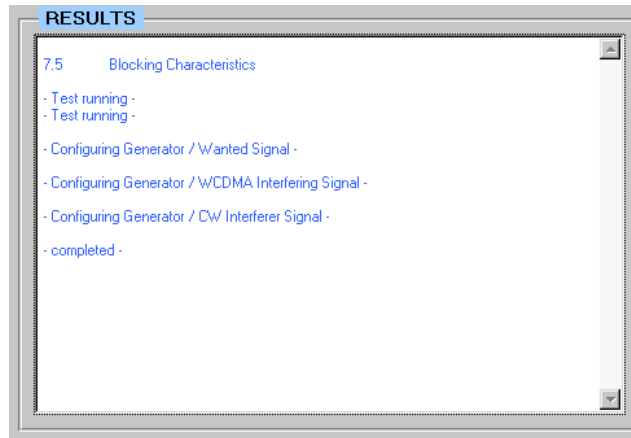

Fig. 37: Blocking Characteristics: output from the demo program

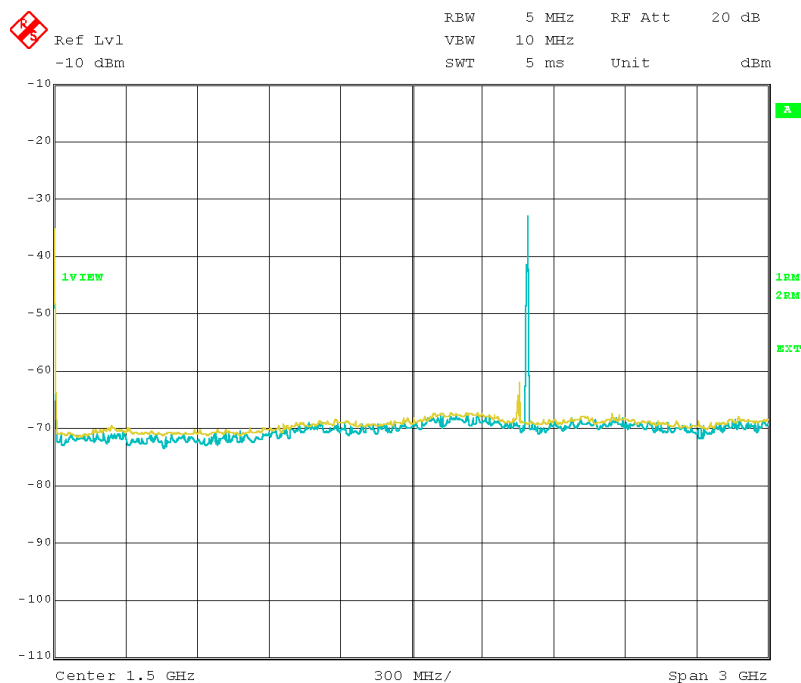

Fig. 38: Blocking Characteristics, snapshot: wanted signal (left peak) and interfering WCDMA signal (right peak).

Intermodulation Characteristics (7.6)

Third and higher order mixing of the two interfering RF signals can produce an interfering signal in the band of the desired channel. Intermodulation response rejection is a measure of the capability of the receiver to receive a wanted signal on its assigned channel frequency in the presence of two or

more interfering signals which have a specific frequency relationship to the wanted signal.

The test purpose is to verify the ability of the BS receiver to inhibit the generation of intermodulation products in its non-linear elements caused by the presence of two high-level interfering signals at frequencies with 10 MHz and 20 MHz offset from the frequency of the wanted signal.

3GDemoBS demonstrates only the principle of this test. It generates the wanted signal at first. After a short delay, the SMIQ will be reconfigured to provide one WCDMA interfering signal at 20 MHz above the wanted signal. Afterwards, a third interferer (a CW9 signal is generated at 10 MHz above the wanted signal).

This set up is for demonstration only. The FSIQ analyzer is programmed to record and display the wanted and interfering signals on one screen.

- To generate a continuous wanted signal, select the test type *Test Signals Only* and activate the corresponding preprogrammed signal, see chapter 9 *Test Signals only* on page 63.
- To simulate testing without a base station, connect SMIQ output to the input of the FSIQ, activate *Signal Settings Demo* on the user panel of the 3GDemoBS program, and configure and start the test setup.

For demonstration:

1. Connect the SMIQ output to FSIQ input port.
2. From the 3GDemoBS user panel select test 7.6 Intermodulation characteristics.
3. Activate *Signal Settings Demo*
4. Configure the test set up by clicking the *Configure* button.
5. Start the test by clicking the *Start* button.

Fig. 39 shows the result output from the demo program, Fig. 40 the result displayed on the analyzer.

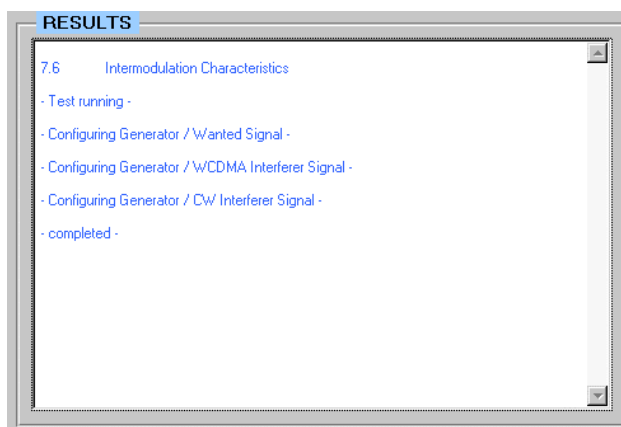

Fig. 39: Intermodulation Characteristics: output from the demo program

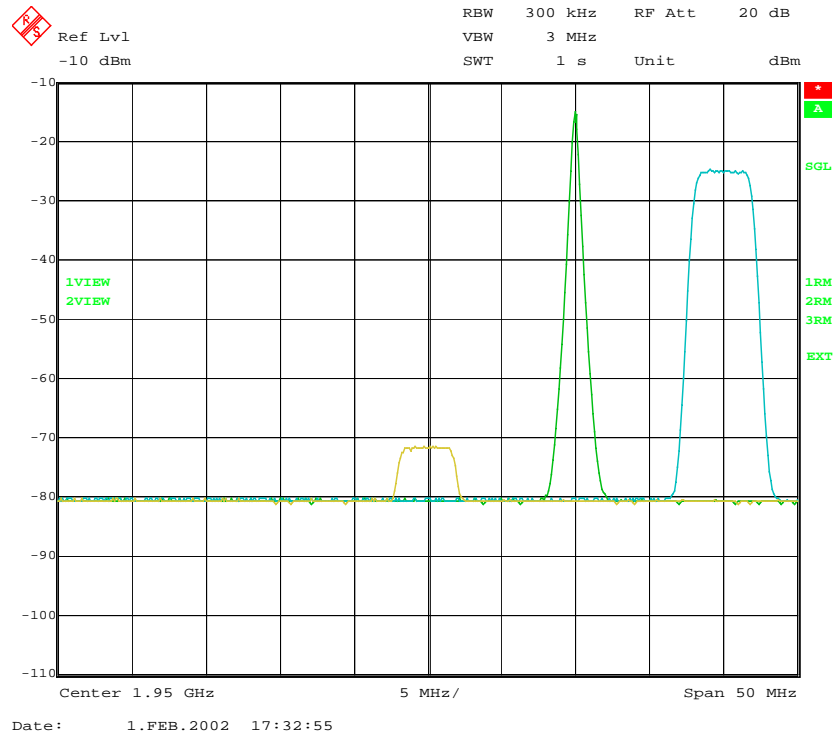

Fig. 40: Intermodulation Characteristics: wanted signal (left), WCDMA interferer (right), and CW interferer (middle).

Spurious Emissions (7.7)

The spurious emission power is the power of the emissions generated or amplified in a receiver that appears at the base station antenna connector. The requirements apply to all base stations with separate RX and TX antenna ports. The test shall be performed when both TX and RX are on with the TX port terminated.

For base stations with a common RX and TX antenna port, the transmitter spurious emission as specified for transmitter test 6.5.3 is valid.

Tests on 3G - Base Stations

The application program 3GDemoBS switches the SMIQ generator off for this test. A 3.84 MHz bandwidth - as stipulated by TS 25.141 for a part of the frequency band - is not yet implemented.

- You need the microwave analyzer FSIQ 26 for this test, because measurements up to 12.7 GHz have to be made. (3GDemoBS stops at 3 GHz to allow demonstration with standard FSIQs.)
- To take full advantage of the analyzer's high measurement dynamic range, TS25.141 stipulates a TX notch filter between the base station and the measurement receiver (FSIQ).

Test procedure:

1. Connect the FSIQ to the base station RX port.
2. Enable the base station receiver.
3. Start base station transmission with channel configuration test model 1.
4. From the 3GDemoBS user panel select test 7.7 Spurious Emissions.
5. Configure the test set up by clicking the *Configure* button.
6. Start the test by clicking the *Start* button.
7. Check the results to the limits in TS 25.141.
8. Repeat the test using diversity antenna connector if available.

Fig. 41 shows the result output from the demo program.

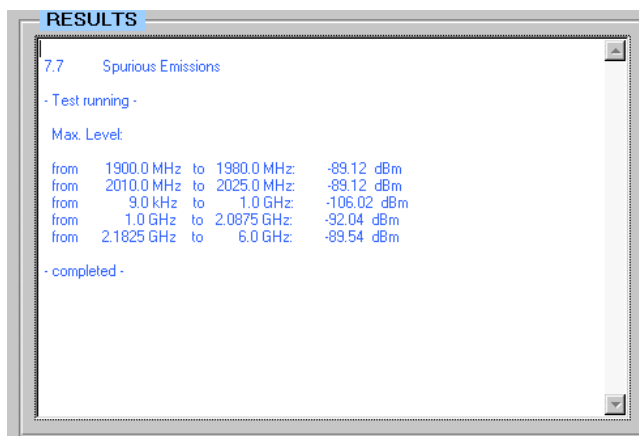

Fig. 41: Spurious Emissions: output from the demo program

Verification of Internal BER Calculation (7.8)

A base station with internal BER calculation can synchronise its receiver to a known pseudo-random data sequence and calculate the bit error ratio from the received data. This test is performed only if the base station has this feature.

This test is performed by feeding a measurement signal with known BER to the input of the receiver.

- For measurements on the base station, disable the FSIQ remote control and Signal Settings Demo from the 3GDemoBS user panel.
- For simulation, connect the SMIQ output to the input of FSIQ, and activate Signal Settings Demo on the 3GDemoBS user panel.

Test procedure on a base station:

1. Connect the SMIQ to the base station antenna port.
2. Set the base station frequency.
3. From the 3GDemoBS user panel select test 7.8 Verification of internal BER calculation.
4. Set *Frequency* of the SMIQ to the base station uplink frequency.
5. Set *Level* of the SMIQ to -111 dBm.
6. Configure the test set up by clicking the *Configure* button.
7. Start the test by clicking the *Start* button.
8. Calculate BER over at least 50,000 received data bits.

The BER indicated by the base station system shall be within +/- 10 % of the BER generated by the RF source.

8 Performance Tests

Performance tests are receiver tests which simulate wave propagation and multipath conditions of a realistic operation scenario. They only apply to a base station with dual receiver antenna diversity.

Table 3 summarises the performance tests stipulated by TS 25.141.

No.	Test	Measurement (BLER)	UL RMC
8	Performance Tests		
8.2	Demod. in static propagation cond.	2 signals + AWGN	4
8.3	Demod. in multipath fading cond.		
8.3.1	Multipath Fading Case 1	2 fading signals + AWGN	4
8.3.2	Multipath Fading Case 2	2 fading signals + AWGN	4
8.3.3	Multipath Fading Case 3	2 fading signals + AWGN	4
8.3.4	Multipath Fading Case 4	2 fading signals + AWGN	4
8.4	Demod. in moving propag. cond.	2 delayed signals + AWGN	2
8.5	Demod. in birth / death prop. cond.	2 alternating signals + AWGN	2
8.6	Verification of int. BLER calculation	1 dirty signal	4

Table 3: Summary of the performance tests

The left column of table 3 contains the number of the chapter in the test specification, the right one shows, how many different uplink reference measurement channels (with different data rates) have to be used subsequently. These tests can be carried out with two SMIQ generators with built in AWGN and fading options.

Test Setup for Performance Tests

Figure 42 shows the general test set up for the performance tests.

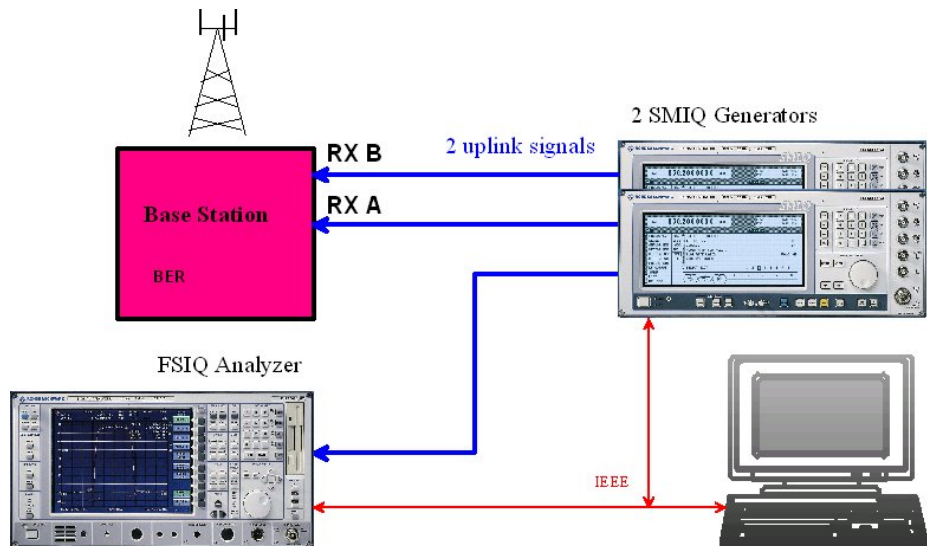

Fig. 42: Test set up for performance tests

Except for test 8.6, you need 2 signal sources. They both provide the same data stream, but with their own fading profiles and additional noise (AWGN). You can easily build up this configuration with two SMIQ generators. For more information, refer to the application note 1GP41 [6].

3GDemoBS demonstrates only the principle of the performance tests. It supports one SMIQ which generates the wanted signal at first without, later with, AWGN. The data rate is set to 12.2 kbps by default.

- For a detailed description how to add a second SMIQ to the test setup, see the application note 1GP41 [6] available from the Rohde & Schwarz website.
- To generate a continuous test signal for any of the performance tests, select the test type *Test Signal Only* and activate the corresponding preprogrammed signal, see chapter 9 *Test Signals only* on page 63.

Performance Test Demonstration Step by Step

1. Select a test.
2. Start the configuration by clicking the *Configure* button.

After clicking the *Configure* button, the connected instruments are reset, so that no inadvertent setting disturbs the test. Reset switches the SMIQ to internal reference, whereas the FSIQ's reference setting will be not affected.

The instruments are configured. The extensive calculation of the required uplink measurement channel inside the SMIQ is carried out.

Note: If you do not need the analyzer, disable FSIQ control in the remote control checkbox. This speeds up the configuration.

3. Start the selected test by clicking the *Start* button.

Clicking the *Start* button switches the SMIQ's RF output on. If the FSIQ analyzer is connected, and remote control enabled, the first result is recorded. Except for test 8.6, the AWGN is activated, and the summary signal will be recorded as a second trace by the analyzer.

The LEDs at the user panel indicate the status of the instruments.

Notes: Like the receiver tests, the performance tests according to TS 25.141 work with very low power levels. If you want to monitor these signals, you need a preamplifier for the analyzer. The Demo level, however, is high enough to make the signals fit into the dynamic range of the FSIQ.

For basic information about the receiver and the performance tests with SMIQ, and how to synchronize base station and SMIQ, see application note 1GP41 [6] available from the Rohde & Schwarz website.

Demodulation of DCH in Static Propagation Conditions (8.2)

The performance requirement of DCH in static propagation conditions is determined by the maximum Block Error Ratio (BLER) allowed when the receiver input signal is at a specified E_b/N_0 limit. The BLER is calculated for each of the measurement channels supported by the base station.

Tests on 3G - Base Stations

3GDemoBS only demonstrates the principle of the performance tests. It supports only one SMIQ which generates the wanted signal at first without, later with, AWGN. The data rate is set to 12.2 kbps by default.

- To generate a wanted signal with a different data rate, and a different carrier to noise ratio, select the test type *Test Signals Only* and activate the corresponding preprogrammed signal, see chapter 9 *Test Signals only* on page 63.
- To simulate testing without a base station, connect SMIQ output to the input of the FSIQ.

For demonstration:

1. From the 3GDemoBS user panel select test 8.2 Demodulation of DCH in static propagation conditions.
2. Activate *Signal Settings Demo*.
3. Configure the test setup by clicking the *Configure* button.
4. Start the test by clicking the *Start* button.

Fig. 43 shows the signals displayed on the analyzer.

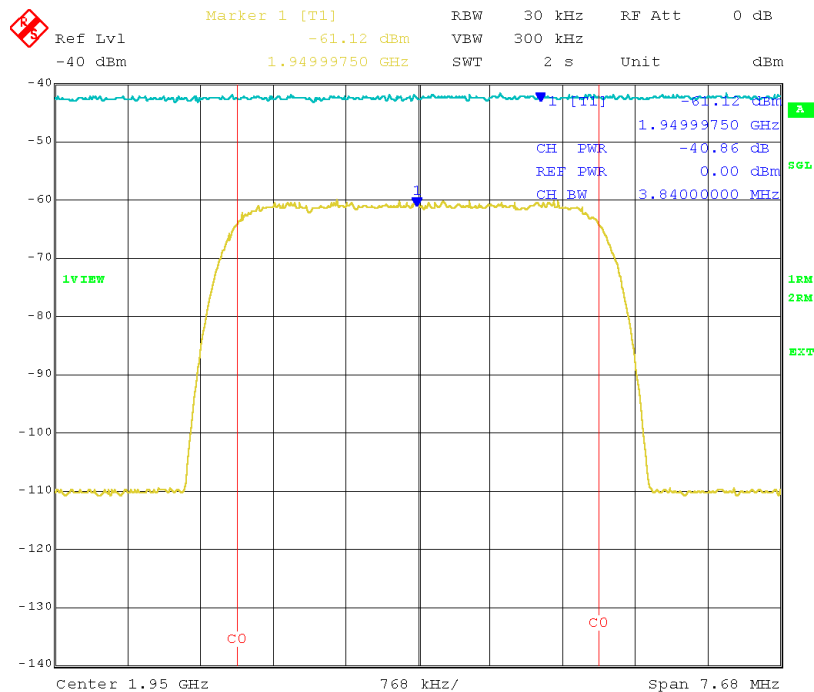

Fig. 43: Uplink signal for performance test 8.2 without AWGN (below) and with AWGN (above).

Demodulation of DCH in Multipath Fading Conditions (8.3)

The performance requirement of DCH in multipath fading Case 1 to 4 is determined by the maximum Block Error Ratio (BLER) allowed when the receiver input signal is at a specified E_b/N_0 limit. The BLER is calculated for each of the measurement channels supported by the base station.

The test shall verify the receiver's ability to receive the test signal under different fading propagation conditions with a BLER not exceeding a specified limit.

3GDemoBS only demonstrates the principle of the performance tests. It supports only one SMIQ which generates the wanted signal at first without, later with, AWGN. The data rate is set to 12.2 kbps by default.

- To generate a wanted signal with a different data rate, and a different carrier to noise ratio, select the test type *Test Signals Only* and activate the corresponding preprogrammed signal, see chapter 9 *Test Signals only* on page 63.
- To simulate testing without a base station, connect SMIQ output to the input of the FSIQ.

For demonstration:

1. From the 3GDemoBS user panel select test 8.3 Demodulation of DCH in multipath fading conditions.
2. Activate *Signal Settings Demo*.
3. Configure the test set up by clicking the *Configure* button.
4. Start the test by clicking the *Start* button.

Fig. 44 to Fig. 47 show the SMIQ signals with the different stipulated fading profiles.

Tests on 3G - Base Stations

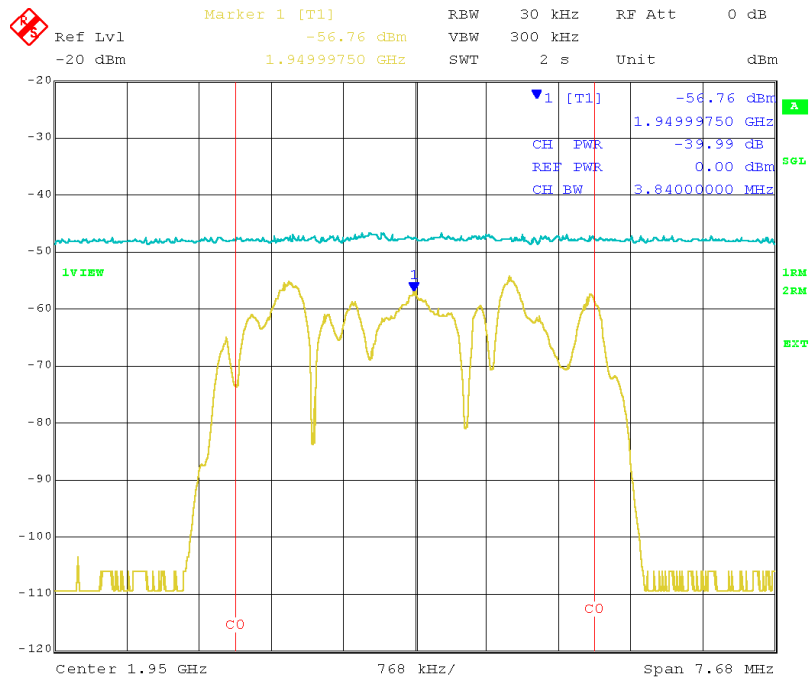

Fig. 44: Multipath fading case 1 without AWGN (below) and with AWGN (above).

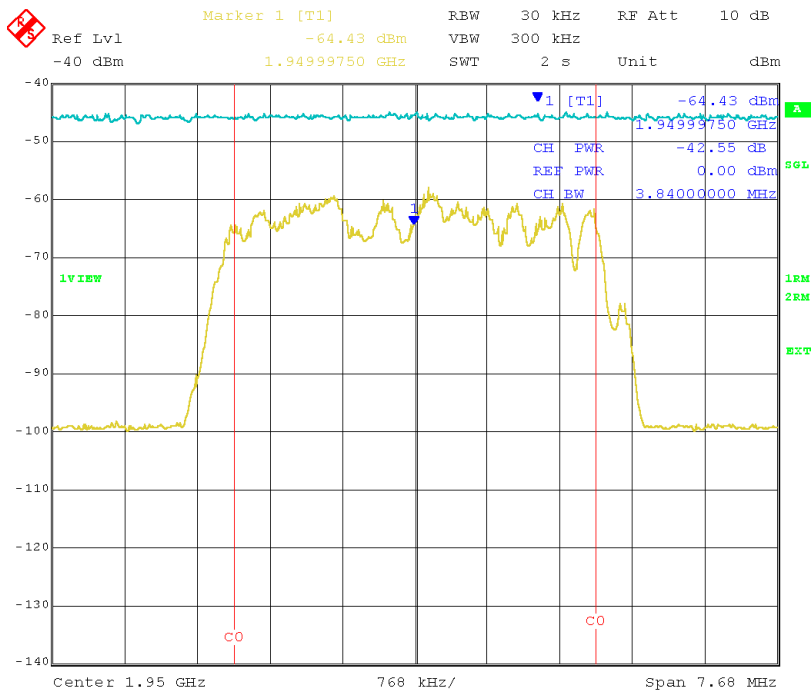

Fig. 45: Multipath fading case 2 without AWGN (below) and with AWGN (above).

Tests on 3G - Base Stations

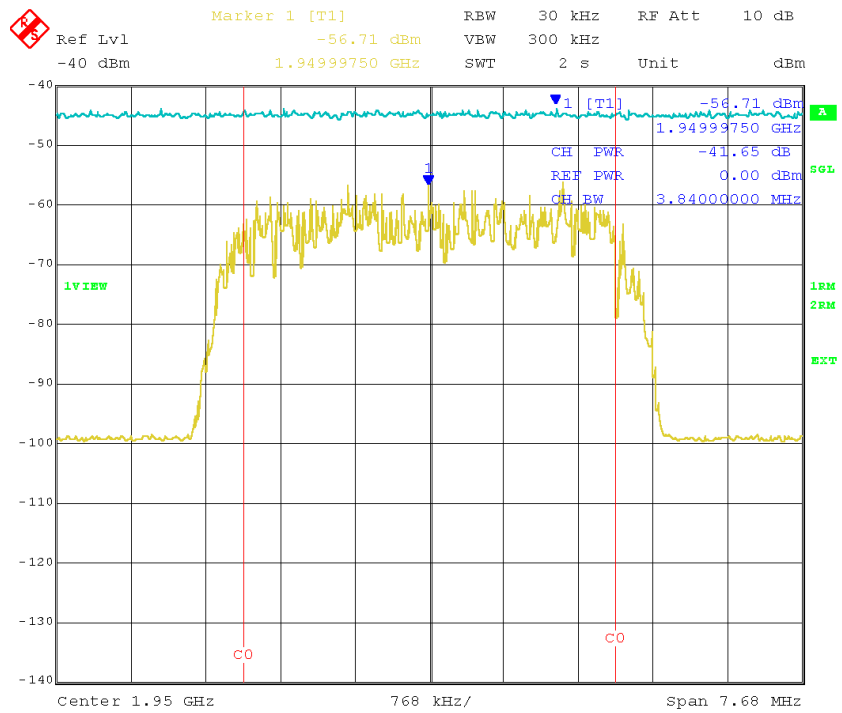

Fig. 46: Multipath fading case 3 without AWGN (below) and with AWGN (above).

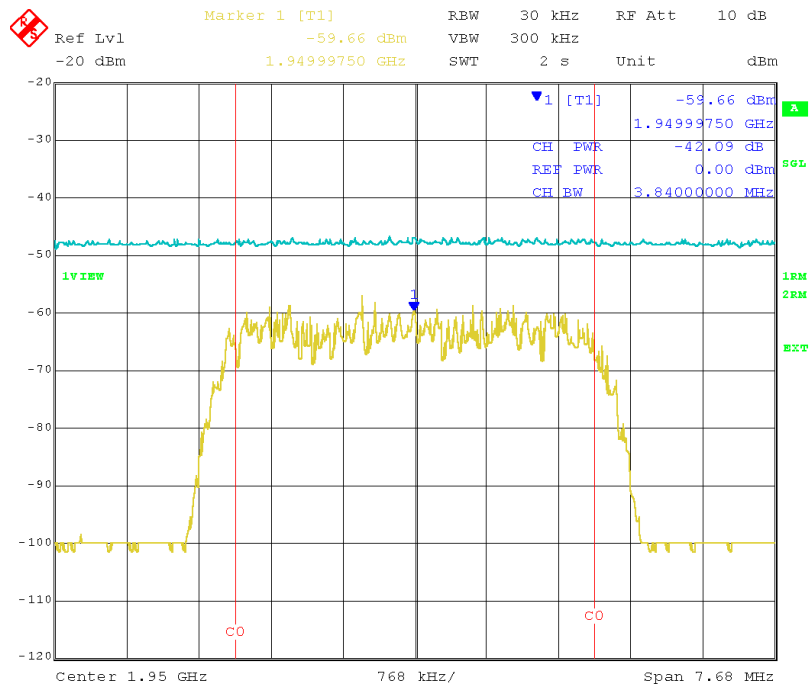

Fig. 47: Multipath fading case 4 without AWGN (below) and with AWGN (above).

Demodulation of DCH in Moving Propagation Conditions (8.4)

The performance requirement of DCH in moving propagation conditions is determined by the maximum Block Error Ratio (BLER) allowed when the receiver input signal is at a specified E_b/N_0 limit. The BLER is calculated for each of the measurement channels supported by the base station.

The test shall verify the receiver's ability to receive and track the test signal with a BLER not exceeding the specified limit.

The application program 3GDemoBS demonstrates only the principle of the performance tests. It supports only one SMIQ which generates the wanted signal at first without, later with, AWGN. The data rate is set to 12.2 kbps by default.

- To generate a wanted signal with a different data rate, and a different carrier to noise ratio, select the test type *Test Signals Only* and activate the corresponding preprogrammed signal, see chapter 9 *Test Signals only* on page 63.
- To simulate testing without a base station, connect SMIQ output to the input of the FSIQ.

For demonstration:

1. From the 3GDemoBS user panel select test 8.4 Demodulation of DCH in moving propagation conditions.
2. Activate *Signal Settings Demo*.
3. Configure the test setup by clicking the *Configure* button.
4. Start the test by clicking the *Start* button.

Fig. 48 shows the signal for moving propagation conditions

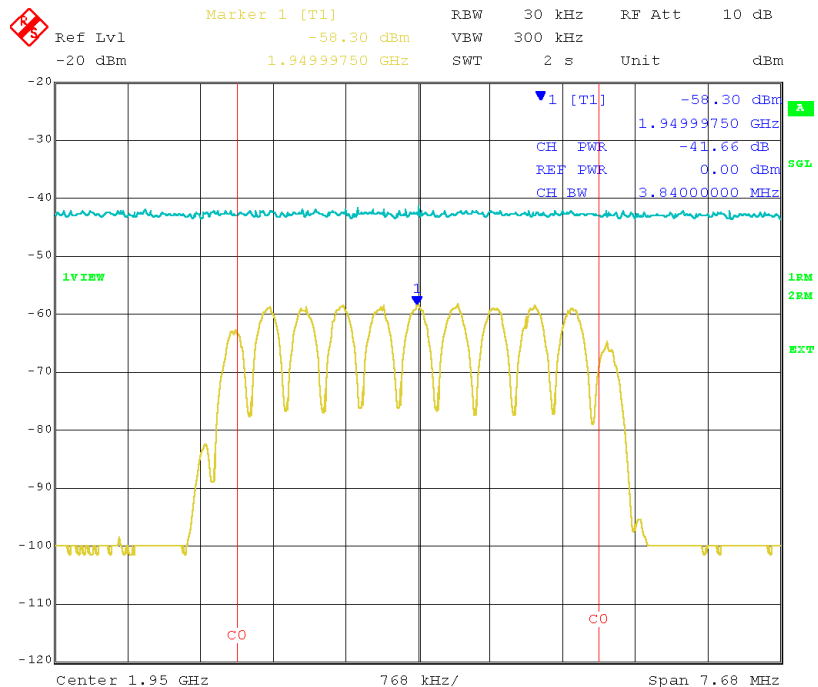

Fig. 48: Signal for moving propagation conditions without AWGN (below) and with AWGN (above).

Demodulation of DCH in Birth / Death Conditions (8.5)

The performance requirement of DCH in birth / death propagation conditions is determined by the maximum Block Error Ratio (BLER) allowed when the receiver input signal is at a specified E_b/N_0 limit. The BLER is calculated for each of the measurement channels supported by the base station.

The test shall verify the receiver ability to receive the test signal to find new multipath components with a BLER not exceeding the specified limit.

The application program 3GDemoBS demonstrates only the principle of the performance tests. It supports only one SMIQ which generates the wanted signal at first without, later with, AWGN. The data rate is set to 12.2 kbps by default.

- To generate a wanted signal with a different data rate, and a different carrier to noise ratio, select the test type *Test Signals Only* and activate the corresponding preprogrammed signal, see chapter 9 *Test Signals only* on page 63.
- To simulate testing without a base station, connect SMIQ output to the input of the FSIQ.

For demonstration:

1. From the 3GDemoBS user panel select test 8.5 Demodulation of DCH in birth / death conditions.
2. Activate *Signal Settings Demo*.
3. Configure the test set up by clicking the *Configure* button.
4. Start the test set up by clicking the *Start* button.

Fig. 49 shows the signal for birth / death propagation conditions.

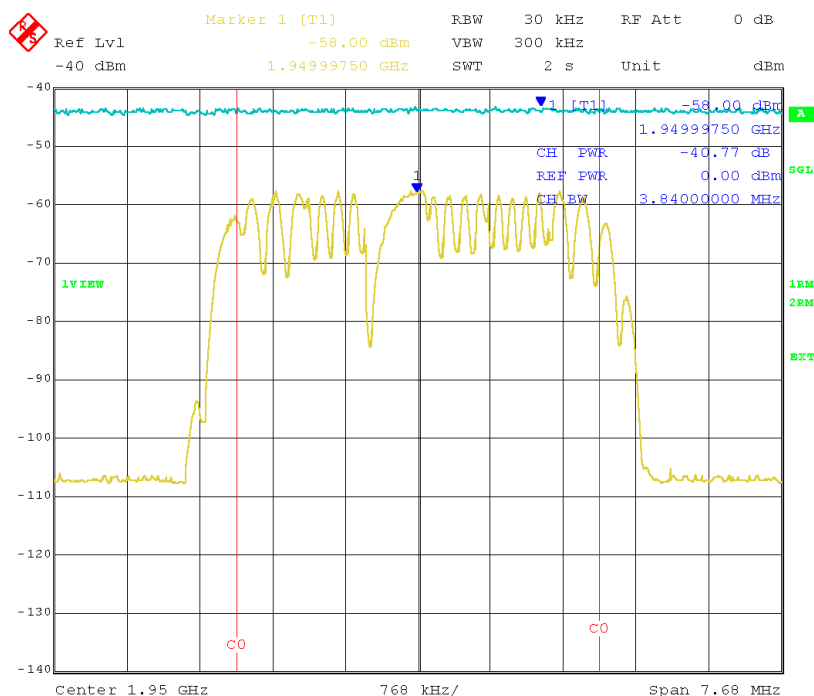

Fig. 49: Signal for birth / dead propagation conditions without AWGN (below) and with AWGN (above).

Verification of Internal BLER Calculation (8.6)

A base station with internal Block Error Rate (BLER) calculation evaluates the BLER from the CRC blocks of the received Dedicated Control Channel DCCH. This test is performed only if the base station has this kind of feature. All data rates which are used in clause 8 Performance requirement testing shall be used in verification testing.

This test is performed by feeding a measurement signal with a known BLER to the input of the receiver.

- For measurements on a base station, disable the remote control of FSIQ, and Signal Settings Demo from the 3GDemoBS user panel.
- To generate a wanted signal with a different data rate, and a different carrier to noise ratio, select the test type *Test Signals Only* and activate

the corresponding preprogrammed signal, see chapter 9 *Test Signals only* on page 63.

- To simulate testing without a base station, connect SMIQ output to the input of the FSIQ.

Test procedure on a base station:

1. Connect SMIQ - to the base station antenna port.
2. Set the base station frequency.
3. From the 3GDemoBS user panel select test 8.6 Verification of internal BLER calculation.
4. Set *Frequency* of SMIQ to the DUT uplink frequency.
5. Set *Level* of SMIQ to -111 dBm.
6. Configure the set up by clicking the *Configure* button.
7. Start the test by clicking the *Start* button.
8. Calculate BLER at least over 50,000 blocks.

BLER indicated by the base station system shall be within +/- 10% of the BLER generated by the RF signal source.

9 Test Signals Only

Table 4 contains a list of the test signals currently provided by the program 3GDemoBS. The signal configuration refers to the version number of the test specification that you can find on the lower left corner of the user panel.

Test Model 1
Test Model 2
Test Model 3
Test Model 4
Uplink RMC 12.2 kbps (for test 7.2)
Uplink RMC 12.2 kbps with AWGN (for test 7.3)
Uplink RMC 12.2 kbps BER 0.1% (for test 7.8)
Uplink RMC 64 kbps
Uplink RMC 144 kbps
Uplink RMC 384 kbps

Table 4: Test Signals available

This part of the demo program only makes sense, if an SMIQ with remote control enabled is connected to your PC.

Synchronising Base Station and SMIQ

For receiving uplink signals, the base station and the generator of the uplink signal have to be synchronized. Normally, the base station plays the role of a master, which provides the 10 MHz reference and a trigger signal for the generator.

For demonstration, the SMIQ can act as a master as well, with trigger free run and internal 10 MHz reference.

- Select the master device by the setting of the checkbox *Signal Settings Demo*.

If the checkbox *Signal Settings Demo* is set, the SMIQ is master, otherwise the base station is master.

If the base station is master, a suitable trigger is for example a signal indicating the Super Frame Number (SFN) restart which is provided by most of the base stations.

- Connect this trigger signal to TRIG IN of the PAR DATA connector on the rear panel of the SMIQ. Use SMIQ-Z5 adapter which provides BNC connectors for all pins of the PAR DATA connector.
- Connect the 10 MHz reference signal of the base station to the REF connector on SMIQ's rear panel.

Note: For further details on synchronizing SMIQ and base station, download the application note 1GP41 [6] from the Rohde & Schwarz website.

Generating Test Signals

1. Select your test signal.
2. Start the configuration by clicking the *Configure* button.

After clicking the *Configure* button, the connected instruments will be configured. The calculation of the required test model or uplink RMC inside the SMIQ is initiated. If an FSIQ is present, it will be set up to cope with the selected uplink or downlink test signal.

Note: If you do not need the analyzer, disable the FSIQ's control in the remote control checkbox. This speeds up the configuration.

After configuration, you can modify the setting of the instruments manually, e.g. change the signal / noise ratio of the AWGN.

The RF output of the SMIQ generator is still switched off.

3. Start the selected test by clicking the *Start* button.

Clicking the *Start* button switches the RF output on. If SMIQ is the master, the output of data and frame trigger starts. If the base station is the master, the SMIQ waits for an external trigger signal.

4. Stop the signal output by clicking the *Break* button. This disables the RF output of the generator.

Note: No changes of the instrument settings are performed by 3GDemoBS after clicking *Start*.

10 Literature

- [1] 3rd Generation Partnership Project; Technical Specification Group Radio Access Networks; Base Station conformance testing (FDD) (Release 1999) - TS 25.141 (V4.2.0)
- [2] René Desquiotz, WCDMA Signal Generator Solutions by Rohde & Schwarz, Application Note 1GP39
- [3] Josef Wolf, Measurement on 3GPP Base Station Transmitter Signals, Application Note 1EF44
- [4] Josef Wolf, Measurement of Adjacent Channel Power on Wideband CDMA Signals, Application Note 1EF40
- [5] Josef Wolf and Bob Buxton, Measure Adjacent Channel Power With a Spectrum Analyzer, Microwaves & RF, January 1997
- [6] René Desquiotz, 3GPP FDD Base Station Tests with Vector Signal Generator SMIQ, Application Note 1GP41
- [7] Sander / Wolf, Spurious Emission Measurement on 3GPP Base Station Transmitters, Application Note 1EF45

11 Abbreviations

3GPP	Third Generation Partnership Project. Name of the organization that defines the communication standards of the Third Generation.
AWGN	Additional White Gaussian Noise.
DCH	Dedicated Channel, collectively for DTCH and DCCH.
DTCH	Dedicated Traffic Channel. Transport channel that is mapped to the Dedicated Physical Data Channel (DPDCH).
DCCH	Dedicated Control Channel. Transport channel that is mapped to the Dedicated Physical Data Channel (DPDCH).
DPDCH	Dedicated Physical Data Channel which contains the user data (one or more DTCH and one DCCH)
DPCCH	Dedicated Physical Control Channel. Physical Channel that contains some control information. Among others, the Transmit Power Control (TPC) bits are transmitted in the DPCCH.
FDD	Frequency Division Duplex, means that uplink and downlink transmit on different frequencies.
OCNS	Orthogonal Channel Noise Simulation. A "realistic" 3GPP background signal.
RMC	Reference Measurement Channel. The 3GPP specifications define uplink Reference Measurement Channels for base station conformance tests. These are 3GPP signals with defined parameter values including channel coding. RMCs contain a DPCCH and a DPDCH as physical channels. As transport channels, a DTCH and a DCCH are mapped to the DPDCH.
SFN	System Frame Number. System time unit that is transmitted by the BS in the BCH channel.
TPC	Transmit Power Control. TPC bits are transmitted by a base station or mobile to tell its counterpart to increase or decrease transmit power.

12 Hardware and Software Requirements

3GDemoBS Hardware Requirements for PC

The software runs on a PC with the following features:

- CPU: 486, Pentium or better
- RAM: 16 Mbytes or more
- Monitor: VGA colour monitor
- IEC/IEEE bus: IEC/IEEE-bus interface Rohde & Schwarz IEEE 488.2 bus interface PS-B4, 1006.6207.04 or National Instruments AT-GPIB/TNT

3GDemoBS Software Requirements for PC

- Windows 95/98 or Windows NT (version 4.0 or better)
- GPIB (IEC/IEEE-bus) driver installed

Options required for FSIQ and SMIQ

To run all tests, you need the following options:

SMIQB11	Data Generator 16 Mbit
SMIQB12	Memory Extension 32 Mbit (2x)
SMIQB14	Fading Simulator
SMIQB15	Second Fading Simulator
SMIQB17	Noise Generator and Distortion Simulator
SMIQB20	Modulation Coder
SMIQB45	Dig. Standard WCDMA (3GPP, FDD)
SMIQB48	Extended Functions for WCDMA (3GPP)
SMIQB49	Extended Fading Function for WCDMA
FSIQB70	25.6 MHz Sampling Rate
FSIQK72	3GPP BS Code Domain Power Measurement for FSIQ
FSIQK73	3GPP UE Code Domain Power Measurement for FSIQ

If you want to run only a part of the tests, look at tables 5 to 7 below. They show which options are required for each single test.

Tests on 3G - Base Stations

Transmitter Tests:

	Test	FSIQ-Options	SMIQ-Options
6.2	Base station output power		
6.2.1	Base station maximum output power	B70, K72	B45, B20, B11 *
6.2.2	CPICH power accuracy	B70, K72	B45, B20, B11 *
6.3	Frequency error		
		B70, K72	B45, B20, B11 *
6.4	Output power dynamics		
6.4.2	Power control steps	B70, K72	B45, B20, B11
6.4.3	Power control dynamic range	B70, K72	B45, B20, B11 *
6.4.4	Total power dynamic range	B70, K72	B45, B20, B11 *
6.5	Output RF spectrum emissions		
6.5.1	Occupied bandwidth	B70, K72	B45, B20, B11 *
6.5.2	Out of band emission		
6.5.2.1	Spectrum emission mask	B70, K72	B45, B20, B11 *
6.5.2.2	Adjacent channel leakage ratio	B70, K72	B45, B20, B11 *
6.5.3	Spurious emissions		
6.5.3.4.1	Spurious emissions Category A	-	-
6.5.3.4.2	Spurious emissions Category B	-	-
6.5.3.4.3	Protection of the BS receiver	-	-
6.5.3.4.4	Co-existence with GSM 900	-	-
6.5.3.4.5	Co-existence with DCS 1800	-	-
6.5.3.4.6	Co-existence with PHS	-	-
6.5.3.4.7	Co-existence with adj. services	-	-
6.5.3.4.8	Co-existence with UTRA-TDD	-	-
6.6	Transmit intermodulation		
		B70, K72	B45, B20, B11 *
6.7	Transmit modulation		
6.7.1	Error vector magnitude	B70, K72	B45, B20, B11 *
6.7.2	Peak code domain error	B70, K72	B45, B20, B11 *

* SMIQ only required for demonstration without DUT

Table 5: Instrument options required for transmitter tests

Receiver Tests:

	Test	FSIQ-Options *	SMIQ-Options
7.2	Reference sensivity level	B70, K73	B45, B48, B20, B11, B12, B17
7.3	Dynamic Range	B70, K73	B45, B48, B20, B11, B12, B17
7.4	Adjacent channel selectivity (ACS)	B70, K73	B45, B48, B20, B11, B12, B17
7.5	Blocking Characteristics	B70, K73	B45, B48, B20, B11, B12, B17
7.6	Intermodulation characteristics	B70, K73	B45, B48, B20, B11, B12, B17
7.7	Spurious emmissions	-	-
7.8	Verification of int. BER calculation	B70, K73	B45, B48, B20, B11, B12, B17

Table 6: Instrument options required for receiver tests

Performance Tests:

	Test	FSIQ-Options *	SMIQ-Options
8.2	Demod. in static propagation cond.	B70, K73	B45, B48, B20, B11, B17, B14, B49
8.3	Demod. in multipath fading cond.	B70, K73	B45, B48, B20, B11, B17, B14, B15, B49
8.3.1	Multipath Fading Case 1		
8.3.2	Multipath Fading Case 2		
8.3.3	Multipath Fading Case 3		
8.3.4	Multipath Fading Case 4		
8.4	Demod. in moving propag. cond.	B70, K73	B45, B48, B20, B11, B17, B14, B49
8.5	Demod. in birth / death prop. cond.	B70, K73	B45, B48, B20, B11, B17, B14, B49
8.6	Verification of int. BLER calculation	B70, K73	B45, B48, B20, B11, B17

* FSIQ only required for demonstration

Table 7: Instrument options required for performance tests

13 Ordering information

Vector Signal Generator and Options

SMIQ02B	0,3 MHz...2,2 GHz	1125.5555.02
SMIQ03B	0,3 MHz...3,3 GHz	1125.5555.03
SMIQ04B	0,3 MHz...4,4 GHz	1125.5555.04
SMIQ06B	0,3 MHz...6,4 GHz	1125.5555.06

SMIQB11	Data Generator 16 Mbit	1085.4502.04
SMIQB12	Memory Extension	1085.2800.04
SMIQB14	Fading Simulator	1085.4002.02
SMIQB15	Second Fading Simulator	1085.4402.02
SMIQB17	Noise Generator and Distortion Simulator	1104.9000.02
SMIQB20	Modulation Coder	1125.5190.02
SMIQB45	Dig. Standard WCDMA (3GPP, FDD)	1104.8232.02
SMIQ-B47	Low ACP for CDMA and WCDMA	1125.5090.02
SMIQB48	Extended Functions for WCDMA (3GPP)	1105.0587.02
SMIQB49	Extended Fading Function for WCDMA	1105.1083.02
SMIQ-Z5	PAR DATA BNC ADAPTER	1104.8584.02

Signal Analyzer and Options

FSIQ3	20 Hz... 3,5 GHz	1119.5005.13
FSIQ7	20 Hz... 7 GHz	1119.5005.17
FSIQ26	20 Hz... 26,5 GHz	1119.6001.27
FSIQ40	20 Hz... 40 GHz	1119.6001.40
FSIQB70	25.6 MHz Sampling Rate	1119.6747.02
FSIQK72	3GPP BS Code Domain Power Measurement for FSIQ	1126.4746.02
FSIQK73	3GPP UE Code Domain Power Measurement for FSIQ	1153.1009.02

Further instruments from the Rohde & Schwarz product line useful for 3GPP measurements:

TS8950 B1	RF Precompliance Tester for WCDMA FDDa Node B	
CMU200	Universal Radio Communication Tester	1100.0008.02
CMU300		1100.0008.03

14 Contact

Please contact TM-Applications@rsd.rohde-schwarz.com for comments and further suggestions.



ROHDE & SCHWARZ GmbH & Co. KG · Mühldorfstraße 15 · D-81671 München · P.O.B 80 14 69 · D-81614 München ·
Telephone +49 89 4129 -0 · Fax +49 89 4129 - 13777 · Internet: <http://www.rohde-schwarz.com>

This application note and the supplied programs may only be used subject to the conditions of use set forth in the download area of the Rohde & Schwarz website